



www.zimed.com.tr

product catalog

Arthroplasty | Trauma | Arthroscopy | Spine

zimed[®]

07

Plate Systems



Large Fragment Locking Plate System	4
Small Fragment Locking Plate System	12
Locking Mini Plate Systems	29
Locking DHS-DCS Plates	31

37

Arthroplasty Systems



Hip Joint Prosthesis	34
Hip Revision Joint Prosthesis	37
Total Knee Joint Prosthesis	39
Vision-R Knee	42

43

Nail Systems



PFNA Nail Systems	47
ZFN Multi-Purpose Femoral Nail Systems	49
Femur-Tibia Arthrodesis Nail Systems	50
Retrograde Femoral Nail	51
ZTN Tibial Nail Systems	52
Cannulated Intramedullary Humeral Nail	53
Titanium Elastic Nail	54

53

External Fixation Systems



External Fixators	57
External Hybrid Fixators	60
Small External Tubular Fixator Set	61
Large External Tubular Fixator Set	62

Skeletal Pins and Wires **63**

Spinal Systems **64**

Arthroscopy **65**

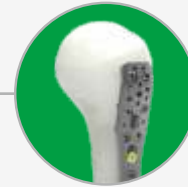

Plate Systems⁺

Large Fragment Locking Plate System	4
Small Fragment Locking Plate System	12
Locking DHS-DCS Plates	29
Locking Mini Plate Systems	31



Arthroplasty Systems



Nail Systems



External Fixation Systems

Skeletal Pins and Wires

Spinal Systems

Arthroscopy

ORTHOPEDIC SYSTEMS



Plate Systems

Large Fragment Locking Plate System

Plate Systems & Screws

Large Fragment Locking Plate System

- Large Fragment Screws
- Small Fragment Locking Plate System
- Pelvic & Acetabulum Plate System
- Small Fragment Screw
- Cannulated Screws
- Headless Cannulated Screws
- Locking Mini Plate System
- Locking DHS-DCS Plate System

Arthroplasty Systems

- Hip Joint Prosthesis
- Revision Hip Joint Prosthesis
- Total Knee Joint Prosthesis
- Vision-R Knee

Nail System

- PFNA Nail System
- ZFN Multi-Purpose Femoral Nail Systems
- Femur-Tibia Arthrodesis Nail Systems
- Retrograde Femoral Nail
- ZTN Tibial Nail Systems
- Cannulated Intramedullary Humeral Nail
- Titanium Elastic Nail

External Fixation System

- External Fixator
- External Hybrid Fixator
- Small External Tubular Fixator
- Large External Tubular Fixator

- Skeletal Pin and Wires
- Spinal System
- Arthroscopy

Locking Proximal Medial Tibial Plate with \varnothing 5.0 - \varnothing 4.5 mm screw

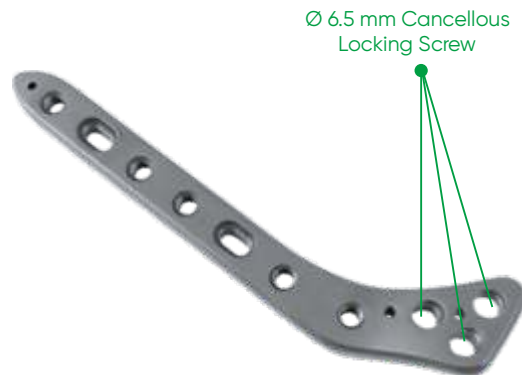

REF. NO	HOLES
1572-1008	8-R
1572-1010	10-R
1572-1012	12-R
1572-1014	14-R
1572-1016	16-R
1572-2008	8-L
1572-2010	10-L
1572-2012	12-L
1572-2014	14-L
1572-2016	16-L

REF. NO	HOLES
1822-1008	8-R
1822-1010	10-R
1822-1012	12-R
1822-1014	14-R
1822-1016	16-R
1822-2008	8-L
1822-2010	10-L
1822-2012	12-L
1822-2014	14-L
1822-2016	16-L

Locking Proximal Lateral Tibial L Plate with \varnothing 5.0 - \varnothing 4.5 mm screw

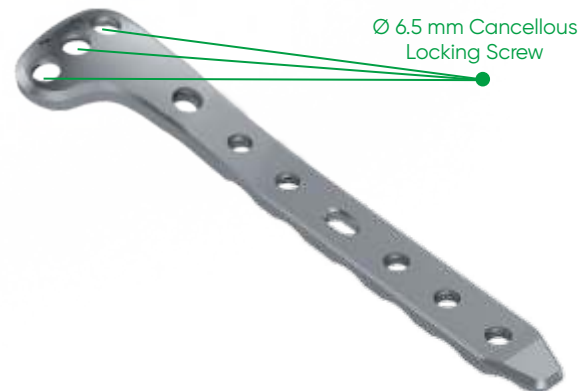

Locking Proximal Medial Tibial T Plate with \varnothing 5.0 - \varnothing 4.5 mm screw

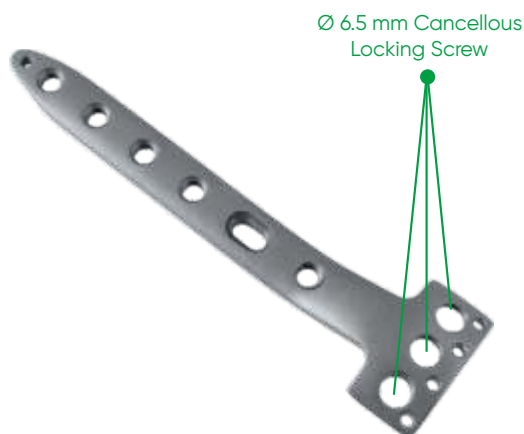

REF. NO	HOLES
1792-1007	7-R
1792-1009	9-R
1792-1011	11-R
1792-2007	7-L
1792-2009	9-L
1792-2011	11-L

Plate Systems

Large Fragment Locking Plate System



Locking Distal Anterolateral Tibial Plate
with \varnothing 3.5 mm screw

\varnothing 4,0 mm Cancellous
Locking Screw



REF. NO	HOLES
10132-10010	10 - R
10132-10012	12- R
10132-10014	14 - R
10132-10016	16 - R
10132-10018	18- R
10132-20010	10 - L
10132-20012	12 - L
10132-20014	14 - L
10132-20016	16 - L
10132-20018	18 - L

REF. NO	HOLES
1032-1013	13-R
1032-1015	15-R
1032-1017	17-R
1032-1019	19-R
1032-1021	21-R
1032-2013	13-L
1032-2015	15-L
1032-2017	17-L
1032-2019	19-L
1032-2021	21-L

Locking Distal Medial Tibial Point Plate (3.5-5.0 Combined)
with \varnothing 3.5 - \varnothing 5.0 mm screw

\varnothing 3.5 mm Locking Screw

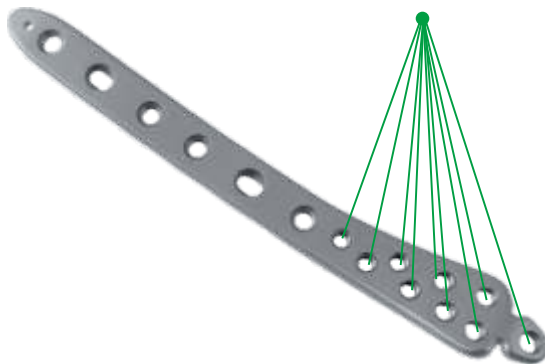

Locking Distal Lateral Tibial Plate
with \varnothing 5.0 - \varnothing 4.5 mm screw

\varnothing 6.5 mm Cancellous
Locking Screw

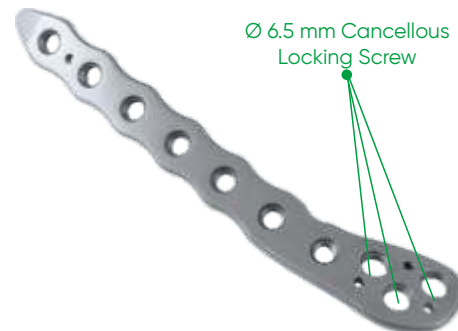

REF. NO	HOLES
1582-1008	8-R
1582-1010	10-R
1582-1012	12-R
1582-1014	14-R
1582-1016	16-R
1582-2008	8-L
1582-2010	10-L
1582-2012	12-L
1582-2014	14-L
1582-2016	16-L

Plate Systems & Screws

Large Fragment Locking Plate System

- Large Fragment Screws
- Small Fragment Locking Plate System
- Pelvic & Acetabulum Plate System
- Small Fragment Screw
- Cannulated Screws
- Headless Cannulated Screws
- Locking Mini Plate System
- Locking DHS-DCS Plate System

Arthroplasty Systems

- Hip Joint Prosthesis
- Revision Hip Joint Prosthesis
- Total Knee Joint Prosthesis
- Vision-R Knee

Nail System

- PFNA Nail System
- ZFN Multi-Purpose Femoral Nail Systems
- Femur-Tibia Arthrodesis Nail Systems
- Retrograde Femoral Nail
- ZTN Tibial Nail Systems
- Cannulated Intramedullary Humeral Nail
- Titanium Elastic Nail

External Fixation System

- External Fixator
- External Hybrid Fixator
- Small External Tubular Fixator
- Large External Tubular Fixator

- Skeletal Pin and Wires
- Spinal System
- Arthroscopy



Plate Systems

Large Fragment Locking Plate System

Plate Systems & Screws

Large Fragment Locking Plate System

- Large Fragment Screws
- Small Fragment Locking Plate System
- Pelvic & Acetabulum Plate System
- Small Fragment Screw
- Cannulated Screws
- Headless Cannulated Screws
- Locking Mini Plate System
- Locking DHS-DCS Plate System

Arthroplasty Systems

- Hip Joint Prosthesis
- Revision Hip Joint Prosthesis
- Total Knee Joint Prosthesis
- Vision-R Knee

Nail System

- PFNA Nail System
- ZFN Multi-Purpose Femoral Nail Systems
- Femur-Tibia Arthrodesis Nail Systems
- Retrograde Femoral Nail
- ZTN Tibial Nail Systems
- Cannulated Intramedullary Humeral Nail
- Titanium Elastic Nail

External Fixation System

- External Fixator
- External Hybrid Fixator
- Small External Tubular Fixator
- Large External Tubular Fixator

- Skeletal Pin and Wires
- Spinal System
- Arthroscopy

Locking LC DCP Broad Plate (5.0 mm)
with \varnothing 5.0 - \varnothing 4.5 mm screw



REF. NO	HOLES
1372-0004	4
1372-0005	5
1372-0006	6
1372-0007	7
1372-0008	8
1372-0009	9
1372-0010	10
1372-0011	11
1372-0012	12
1372-0013	13
1372-0014	14
1372-0015	15
1372-0016	16

REF. NO	HOLES
1382-0004	4
1382-0005	5
1382-0006	6
1382-0007	7
1382-0008	8
1382-0009	9
1382-0010	10
1382-0011	11
1382-0012	12
1382-0013	13
1382-0014	14
1382-0015	15
1382-0016	16

Locking LC DCP Narrow Plate (5.0 mm)
with \varnothing 5.0 - \varnothing 4.5 mm screw



Cable Locking LC DCP Broad Plate
with \varnothing 5.0 - \varnothing 4.5 mm screw



REF. NO	HOLES
1982-0004	4
1982-0005	5
1982-0006	6
1982-0007	7
1982-0008	8

Plate Systems

Large Fragment Locking Plate System



REF. NO	HOLES
1542-1013	13-R
1542-1015	15-R
1542-1017	17-R
1542-1019	19-R
1542-1021	21-R
1542-2013	13-L
1542-2015	15-L
1542-2017	17-L
1542-2019	19-L
1542-2021	21-L

Locking Distal Lateral Femoral Plate
with \varnothing 5.0 - \varnothing 4.5 mm screw

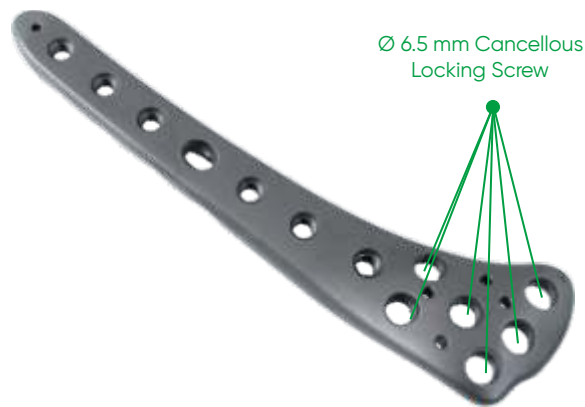

REF. NO	HOLES
1552-1009	9-R
1552-1011	11-R
1552-1013	13-R
1552-1015	15-R
1552-1017	17-R
1552-2009	9-L
1552-2011	11-L
1552-2013	13-L
1552-2015	15-L
1552-2017	17-L

Locking Proximal Lateral Femoral Plate
with \varnothing 5.0 - \varnothing 4.5 mm screw

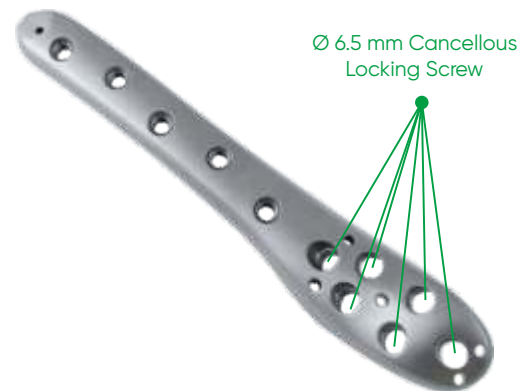

Locking Attachment Plate
with \varnothing 5.0 - \varnothing 4.5 mm screw

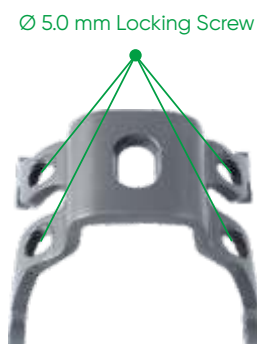

REF. NO	HOLES
10022-00008	8

Locking Attachment Plate Connection Screw 5.0 mm



REF. NO
2912-5000



Plate Systems & Screws

Large Fragment Locking Plate System

- Large Fragment Screws
- Small Fragment Locking Plate System
- Pelvic & Acetabulum Plate System
- Small Fragment Screw
- Cannulated Screws
- Headless Cannulated Screws
- Locking Mini Plate System
- Locking DHS-DCS Plate System

Arthroplasty Systems

- Hip Joint Prosthesis
- Revision Hip Joint Prosthesis
- Total Knee Joint Prosthesis
- Vision-R Knee

Nail System

- PFNA Nail System
- ZFN Multi-Purpose Femoral Nail Systems
- Femur-Tibia Arthrodesis Nail Systems
- Retrograde Femoral Nail
- ZTN Tibial Nail Systems
- Cannulated Intramedullary Humeral Nail
- Titanium Elastic Nail

External Fixation System

- External Fixator
- External Hybrid Fixator
- Small External Tubular Fixator
- Large External Tubular Fixator

- Skeletal Pin and Wires
- Spinal System
- Arthroscopy



Plate Systems

Large Fragment Locking Plate System

Plate Systems & Screws

Large Fragment Locking Plate System

- Large Fragment Screws
- Small Fragment Locking Plate System
- Pelvic & Acetabulum Plate System
- Small Fragment Screw
- Cannulated Screws
- Headless Cannulated Screws
- Locking Mini Plate System
- Locking DHS-DCS Plate System

Arthroplasty Systems

- Hip Joint Prosthesis
- Revision Hip Joint Prosthesis
- Total Knee Joint Prosthesis
- Vision-R Knee

Nail System

- PFNA Nail System
- ZFN Multi-Purpose Femoral Nail Systems
- Femur-Tibia Arthrodesis Nail Systems
- Retrograde Femoral Nail
- ZTN Tibial Nail Systems
- Cannulated Intramedullary Humeral Nail
- Titanium Elastic Nail

External Fixation System

- External Fixator
- External Hybrid Fixator
- Small External Tubular Fixator
- Large External Tubular Fixator

- Skeletal Pin and Wires
- Spinal System
- Arthroscopy

Minimally Invasive Locking Distal Lateral Femoral Plate

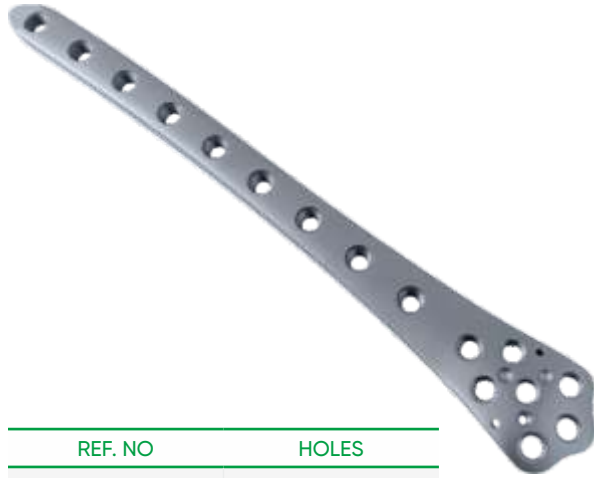

REF. NO	HOLES
1802-1012	12-R
1802-1016	16-R
1802-1020	20-R
1802-2012	12-L
1802-2016	16-L
1802-2020	20-L

Minimally Invasive Locking Proximal Lateral Tibial Plate

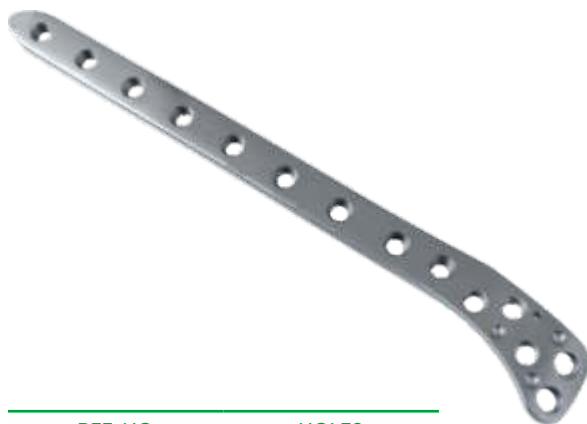

REF. NO	HOLES
1782-1010	10-R
1782-1014	14-R
1782-1018	18-R
1782-2010	10-L
1782-2014	14-L
1782-2018	18-L

Locking Screws Self Drilling 5.0 mm



REF. NO	LENGTH (mm)
2192-5018	18
2192-5020	20
2192-5025	25
2192-5030	30
2192-5035	35
2192-5040	40
2192-5045	45
2192-5050	50
2192-5055	55
2192-5060	60
2192-5065	65
2192-5070	70
2192-5075	75
2192-5080	80
2192-5085	85
2192-5090	90
2192-5095	95
2192-5100	100
2192-5105	105
2192-5110	110
2192-5115	115



Plate Systems

Large Fragment Locking Plate System



Plate Systems & Screws

Locking Proximal Lateral Femoral Head Plate

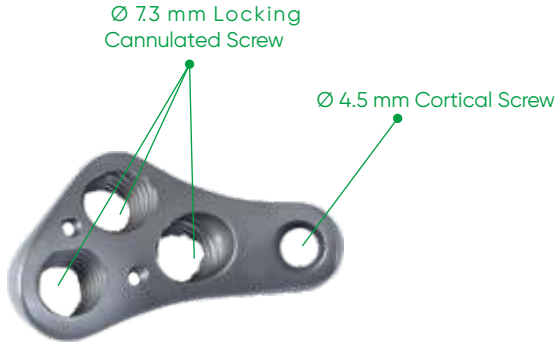

REF. NO	HOLES
1042-1004	4-R
1042-2004	4-L

- Large Fragment Locking Plate System
- Large Fragment Screws
- Small Fragment Locking Plate System
- Pelvic & Acetabulum Plate System
- Small Fragment Screw
- Cannulated Screws
- Headless Cannulated Screws
- Locking Mini Plate System
- Locking DHS-DCS Plate System

Arthroplasty Systems

- Hip Joint Prosthesis
- Revision Hip Joint Prosthesis
- Total Knee Joint Prosthesis
- Vision-R Knee

Nail System

- PFNA Nail System
- ZFN Multi-Purpose Femoral Nail Systems
- Femur-Tibia Arthrodesis Nail Systems
- Retrograde Femoral Nail
- ZTN Tibial Nail Systems
- Cannulated Intramedullary Humeral Nail
- Titanium Elastic Nail

External Fixation System

- External Fixator
- External Hybrid Fixator
- Small External Tubular Fixator
- Large External Tubular Fixator

- Skeletal Pin and Wires
- Spinal System
- Arthroscopy

Locking Cannulated Screw (Ø 7.3 mm) (16 mm Threaded)



REF. NO	LENGTH (mm)
2412-7050	50
2412-7055	55
2412-7060	60
2412-7065	65
2412-7070	70
2412-7075	75
2412-7080	80
2412-7085	85
2412-7090	90
2412-7095	95
2412-7100	100
2412-7105	105
2412-7110	110
2412-7115	115
2412-7120	120

Locking Cannulated Screw (Ø 7.3 mm) (32 mm Threaded)



REF. NO	LENGTH (mm)
2902-7050	50
2902-7055	55
2902-7060	60
2902-7065	65
2902-7070	70
2902-7075	75
2902-7080	80
2902-7085	85
2902-7090	90
2902-7095	95
2902-7100	100
2902-7105	105
2902-7110	110
2902-7115	115
2902-7120	120



Screws

Large Fragment Locking Plate System

Plate Systems & Screws

Large Fragment Locking Plate System

Large Fragment Screws

Small Fragment Locking Plate System

Pelvic & Acetabulum Plate System

Small Fragment Screw

Cannulated Screws

Headless Cannulated Screws

Locking Mini Plate System

Locking DHS-DCS Plate System

Arthroplasty Systems

Hip Joint Prosthesis

Revision Hip Joint Prosthesis

Total Knee Joint Prosthesis

Vision-R Knee

Nail System

PFNA Nail System

ZFN Multi-Purpose Femoral Nail Systems

Femur-Tibia Arthrodesis Nail Systems

Retrograde Femoral Nail

ZTN Tibial Nail Systems

Cannulated Intramedullary Humeral Nail

Titanium Elastic Nail

External Fixation System

External Fixator

External Hybrid Fixator

Small External Tubular Fixator

Large External Tubular Fixator

Skeletal Pin and Wires

Spinal System

Arthroscopy

Locking Screw (Ø 5.0 mm)



REF. NO	LENGTH (mm)
2052-5012	12
2052-5014	14
2052-5016	16
2052-5018	18
2052-5020	20
2052-5022	22
2052-5024	24
2052-5026	26
2052-5028	28
2052-5030	30
2052-5032	32
2052-5034	34
2052-5036	36
2052-5038	38
2052-5040	40
2052-5042	42
2052-5044	44
2052-5046	46
2052-5048	48
2052-5050	50
2052-5055	55
2052-5060	60
2052-5065	65
2052-5070	70
2052-5075	75
2052-5080	80
2052-5085	85
2052-5090	90
2052-5095	95

Locking Cannulated Screw (Ø 5.0 mm)



REF. NO	LENGTH (mm)
2412-5012	12
2412-5014	14
2412-5016	16
2412-5018	18
2412-5020	20
2412-5022	22
2412-5024	24
2412-5026	26
2412-5028	28
2412-5030	30
2412-5032	32
2412-5034	34
2412-5036	36
2412-5038	38
2412-5040	40
2412-5042	42
2412-5044	44
2412-5046	46
2412-5048	48
2412-5050	50
2412-5055	55
2412-5060	60
2412-5065	65
2412-5070	70
2412-5075	75
2412-5080	80
2412-5085	85
2412-5090	90
2412-5095	95

Locking Cancellous Screw (Ø 6.5 mm)



REF. NO	LENGTH (mm)
2182-0030	30
2182-0035	35
2182-0040	40
2182-0045	45
2182-0050	50
2182-0055	55
2182-0060	60
2182-0065	65
2182-0070	70
2182-0075	75
2182-0080	80
2182-0085	85
2182-0090	90
2182-0095	95
2182-0100	100
2182-0105	105
2182-0110	110
2182-0115	115
2182-0120	120

Cable Adapter Locking Screw



REF. NO	LENGTH (mm)
2602-5000	5.0
2602-3500	3.5

Locking Screw Plug



REF. NO	LENGTH (mm)
2052-5000	5.0

Screws

Large Fragment Locking Plate System



Plate Systems & Screws

Cancellous Screw

(Ø 6.5 mm) (16 mm Threaded)



REF. NO	LENGTH (mm)
2402-0030	30
2402-0035	35
2402-0040	40
2402-0045	45
2402-0050	50
2402-0055	55
2402-0060	60
2402-0065	65
2402-0070	70
2402-0075	75
2402-0080	80
2402-0085	85
2402-0090	90
2402-0095	95
2402-0100	100
2402-0105	105
2402-0110	110
2402-0115	115
2402-0120	120

Cancellous Screw

(Ø 6.5 mm) (32 mm Threaded)



REF. NO	LENGTH (mm)
2952-0040	40
2952-0045	45
2952-0050	50
2952-0055	55
2952-0060	60
2952-0065	65
2952-0070	70
2952-0075	75
2952-0080	80
2952-0085	85
2952-0090	90
2952-0095	95
2952-0100	100
2952-0105	105
2952-0110	110
2952-0115	115
2952-0120	120

Cortical Screw

(Ø 4.5 mm)



REF. NO	LENGTH (mm)
2012-4512	12
2012-4514	14
2012-4516	16
2012-4518	18
2012-4520	20
2012-4522	22
2012-4524	24
2012-4526	26
2012-4528	28
2012-4530	30
2012-4532	32
2012-4534	34
2012-4536	36
2012-4538	38
2012-4540	40
2012-4542	42
2012-4544	44
2012-4546	46
2012-4548	48
2012-4550	50
2012-4552	52
2012-4554	54
2012-4556	56
2012-4558	58
2012-4560	60
2012-4565	65
2012-4570	70
2012-4575	75
2012-4580	80
2012-4585	85
2012-4590	90

Arthroplasty Systems

- Hip Joint Prosthesis
- Revision Hip Joint Prosthesis
- Total Knee Joint Prosthesis
- Vision-R Knee

Nail System

- PFNA Nail System
- ZFN Multi-Purpose Femoral Nail Systems
- Femur-Tibia Arthrodesis Nail Systems
- Retrograde Femoral Nail
- ZTN Tibial Nail Systems
- Cannulated Intramedullary Humeral Nail
- Titanium Elastic Nail

External Fixation System

- External Fixator
- External Hybrid Fixator
- Small External Tubular Fixator
- Large External Tubular Fixator

- Skeletal Pin and Wires
- Spinal System
- Arthroscopy



Plate Systems

Small Fragment Locking Plate System

REF. NO	HOLES
1682-1008	8-R
1682-1010	10-R
1682-1012	12-R
1682-1014	14-R
1682-2008	8-L
1682-2010	10-L
1682-2012	12-L
1682-2014	14-L

Locking Distal Lateral Humeral Plate

with \varnothing 3,5 - \varnothing 4.0 mm screw



REF. NO	HOLES
1532-1008	8-R
1532-1010	10-R
1532-1012	12-R
1532-1014	14-R
1532-1016	16-R
1532-2008	8-L
1532-2010	10-L
1532-2012	12-L
1532-2014	14-L
1532-2016	16-L

Locking Distal Medial Humeral Plate

with \varnothing 3,5 - \varnothing 4.0 mm screw



Locking Distal Humeral Y Plate

with \varnothing 3,5 - \varnothing 4.0 mm screw



REF. NO	HOLES
1512-1009	9-R
1512-1010	10-R
1512-1011	11-R
1512-1012	12-R
1512-2009	9-L
1512-2010	10-L
1512-2011	11-L
1512-2012	12-L

Locking Distal Posterior Humeral Plate

with \varnothing 3,5 - \varnothing 4.0 mm screw



REF. NO	HOLES
1502-1008	8-R
1502-1010	10-R
1502-1012	12-R
1502-2008	8-L
1502-2010	10-L
1502-2012	12-L

Plate Systems & Screws

- Large Fragment Locking Plate System
- Large Fragment Screws
- Small Fragment Locking Plate System**
- Pelvic & Acetabulum Plate System
- Small Fragment Screw
- Cannulated Screws

Arthroplasty Systems

- Hip Joint Prosthesis
- Revision Hip Joint Prosthesis
- Total Knee Joint Prosthesis
- Vision-R Knee

Nail System

- PFNA Nail System
- ZFN Multi-Purpose Femoral Nail Systems
- Femur-Tibia Arthrodesis Nail Systems
- Retrograde Femoral Nail
- ZTN Tibial Nail Systems
- Cannulated Intramedullary Humeral Nail
- Titanium Elastic Nail

External Fixation System

- External Fixator
- External Hybrid Fixator
- Small External Tubular Fixator
- Large External Tubular Fixator

- Skeletal Pin and Wires
- Spinal System
- Arthroscopy

Plate Systems

Small Fragment Locking Plate System

zimed[®]

Plate Systems & Screws

Large Fragment Locking Plate System

Large Fragment Screws

Small Fragment Locking Plate System

Pelvic & Acetabulum Plate System

Small Fragment Screw

Cannulated Screws

Headless Cannulated Screws

Locking Mini Plate System

Locking DHS-DCS Plate System

Arthroplasty Systems

Hip Joint Prosthesis

Revision Hip Joint Prosthesis

Total Knee Joint Prosthesis

Vision-R Knee

Nail System

PFNA Nail System

ZFN Multi-Purpose Femoral Nail Systems

Femur-Tibia Arthrodesis Nail Systems

Retrograde Femoral Nail

ZTN Tibial Nail Systems

Cannulated Intramedullary Humeral Nail

Titanium Elastic Nail

External Fixation System

External Fixator

External Hybrid Fixator

Small External Tubular Fixator

Large External Tubular Fixator

Skeletal Pin and Wires

Spinal System

Arthroscopy

REF. NO	HOLES
1662-1008	8-R
1662-1010	10-R
1662-1012	12-R
1662-1014	14-R
1662-1016	16-R
1662-2008	8-L
1662-2010	10-L
1662-2012	12-L
1662-2014	14-L
1662-2016	16-L



Locking Olecranon Plate

with \varnothing 3,5 - \varnothing 4.0 mm screw

Locking Proximal Lateral Humeral Plate (LARGE)

with \varnothing 3,5 - \varnothing 4.0 mm screw

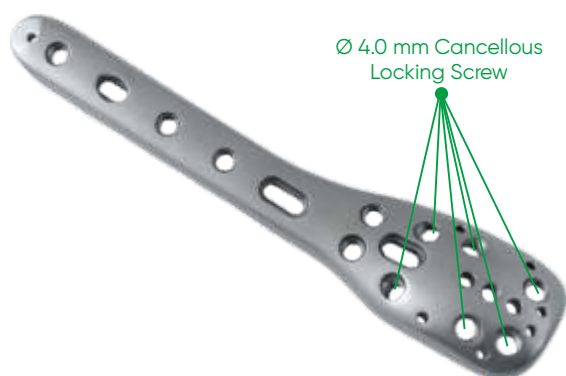

REF. NO	HOLES
1832-1012	12-R
1832-1014	14-R
1832-1016	16-R
1832-1018	18-R
1832-1020	20-R
1832-2012	12-L
1832-2014	14-L
1832-2016	16-L
1832-2018	18-L
1832-2020	20-L

Minimally Invasive Locking Proximal Lateral Humeral Plate (SMALL)

with \varnothing 3,5 mm screw

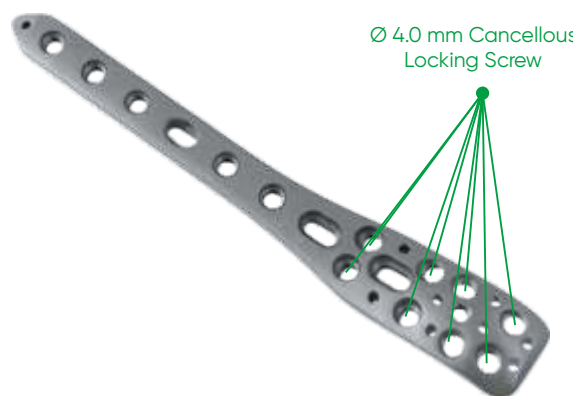

REF. NO	HOLES
1912-1012	12-R
1912-1014	14-R
1912-1016	16-R
1912-1018	18-R
1912-1020	20-R
1912-2012	12-L
1912-2014	14-L
1912-2016	16-L
1912-2018	18-L
1912-2020	20-L



Plate Systems

Small Fragment Locking Plate System

Plate Systems & Screws

Large Fragment Locking Plate System

Large Fragment Screws

Small Fragment Locking Plate System

Pelvic & Acetabulum Plate System

Small Fragment Screw

Cannulated Screws

Headless Cannulated Screws

Locking Mini Plate System

Locking DHS-DCS Plate System

Arthroplasty Systems

Hip Joint Prosthesis

Revision Hip Joint Prosthesis

Total Knee Joint Prosthesis

Vision-R Knee

Nail System

PFNA Nail System

ZFN Multi-Purpose Femoral Nail Systems

Femur-Tibia Arthrodesis Nail Systems

Retrograde Femoral Nail

ZTN Tibial Nail Systems

Cannulated Intramedullary Humeral Nail

Titanium Elastic Nail

External Fixation System

External Fixator

External Hybrid Fixator

Small External Tubular Fixator

Large External Tubular Fixator

Skeletal Pin and Wires

Spinal System

Arthroscopy

Locking Lc Dcp Broad Plate 3.5 mm
with $\varnothing 3,5 - \varnothing 4.0$ mm screw



REF. NO	HOLES
1402-0004	4
1402-0005	5
1402-0006	6
1402-0007	7
1402-0008	8
1402-0009	9
1402-0010	10
1402-0011	11
1402-0012	12
1402-0013	13
1402-0014	14

REF. NO	HOLES
1392-0004	4
1392-0005	5
1392-0006	6
1392-0007	7
1392-0008	8
1392-0009	9
1392-0010	10
1392-0011	11
1392-0012	12
1392-0013	13
1392-0014	14

Locking LC Dcp Narrow Plate 3.5 mm
with $\varnothing 3,5 - \varnothing 4.0$ mm screw

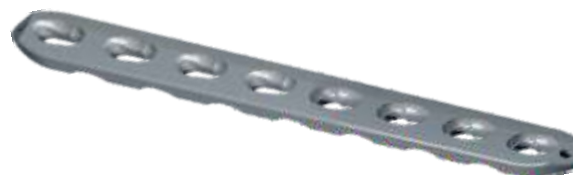

Locking One-Third Tubular Plate
with $\varnothing 3,5 - \varnothing 4.0$ mm screw



REF. NO	HOLES
1432-0004	4
1432-0005	5
1432-0006	6
1432-0007	7
1432-0008	8
1432-0009	9
1432-0010	10
1432-0011	11
1432-0012	12
1432-0013	13
1432-0014	14

Plate Systems

Small Fragment Locking Plate System

zimed[®]

Plate Systems & Screws

Locking Distal Radius Plate - Volar

with Ø 2,4 - Ø 3.5 mm screw



REF. NO	HOLES
1442-1012	12-R
1442-1013	13-R
1442-1014	14-R
1442-1015	15-R
1442-1016	16-R
1442-1017	17-R
1442-2012	12-L
1442-2013	13-L
1442-2014	14-L
1442-2015	15-L
1442-2016	16-L
1442-2017	17-L

Locking Distal Radius Plate - Volar / LARGE

with Ø 2,4 - Ø 3.5 mm screw

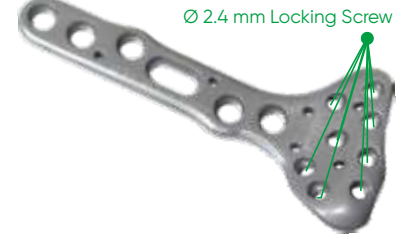

REF. NO	HOLES
9922-1012	12-R
9922-1013	13-R
9922-1014	14-R
9922-1015	15-R
9922-1016	16-R
9922-1017	17-R
9922-2012	12-L
9922-2013	13-L
9922-2014	14-L
9922-2015	15-L
9922-2016	16-L
9922-2017	17-L

Arthroplasty Systems

Distal Radius Volar Plate

with Ø 2,4 - Ø 3.5 mm screw



REF. NO	HOLES
10022-1017	17-R
10022-2017	17-L

Distal Radius Volar Extension Plate

with Ø 2,4 - Ø 3.5 mm screw



REF. NO	HOLES
10032-1006	6-R
10032-1009	9-R
10032-1012	12-R
10032-2006	6-L
10032-2009	9-L
10032-2012	12-L

Volar Plate Extension Connection Screw



REF. NO
2972-0000

Nail System

REF. NO	HOLES
1992-1010	10 - R
1992-1011	11 - R
1992-1012	12 - R
1992-1013	13 - R
1992-1014	14 - R
1992-1015	15 - R
1992-2010	10 - L
1992-2011	11 - L
1992-2012	12 - L
1992-2013	13 - L
1992-2014	14 - L
1992-2015	15 - L

Locking Distal Radius Plate - Dorsal

with Ø 2,4 - Ø 3.5 mm screw

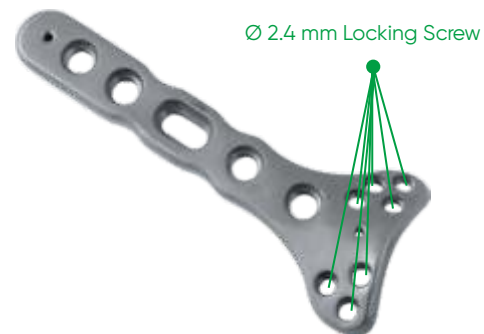

External Fixation System

- External Fixator
- External Hybrid Fixator
- Small External Tubular Fixator
- Large External Tubular Fixator

- Skeletal Pin and Wires
- Spinal System
- Arthroscopy



Plate Systems

Small Fragment Locking Plate System

REF. NO	HOLES
8732-1007	7-R
8732-1008	8-R
8732-1009	9-R
8732-2007	7-L
8732-2008	8-L
8732-2009	9-L

Locking Distal Ulna Plate

with $\varnothing 3,5 - \varnothing 4.0$ mm screw

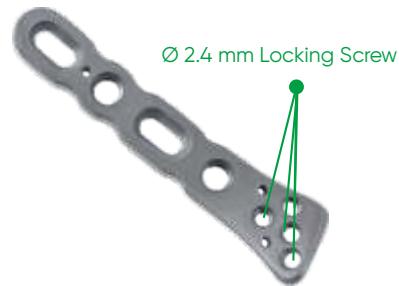

REF. NO	HOLES
8762-0006	6
8762-0007	7
8762-0008	8

Locking Proximal Radial Head Plate

with $\varnothing 3,5 - \varnothing 4.0$ mm screw

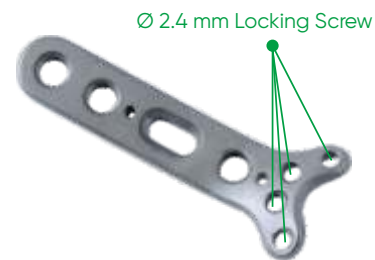

Locking Distal Medial Tibial Point Plate 3.5 mm

with $\varnothing 3,5 - \varnothing 4.0$ mm screw



REF. NO	HOLES
1412-1013	13-R
1412-1015	15-R
1412-1017	17-R
1412-1019	19-R
1412-1021	21-R
1412-2013	13-L
1412-2015	15-L
1412-2017	17-L
1412-2019	19-L
1412-2021	21-L

REF. NO	HOLES
1752-1009	9-R
1752-1011	11-R
1752-1013	13-R
1752-1015	15-R
1752-1017	17-R
1752-2009	9-L
1752-2011	11-L
1752-2013	13-L
1752-2015	15-L
1752-2017	17-L

Locking Proximal Lateral Femoral Plate 3.5 mm

with $\varnothing 3,5 - \varnothing 4.0$ mm screw



Plate Systems & Screws

- Large Fragment Locking Plate System
- Large Fragment Screws
- Small Fragment Locking Plate System**
- Pelvic & Acetabulum Plate System
- Small Fragment Screw
- Cannulated Screws
- Headless Cannulated Screws
- Locking Mini Plate System
- Locking DHS-DCS Plate System

Arthroplasty Systems

- Hip Joint Prosthesis
- Revision Hip Joint Prosthesis
- Total Knee Joint Prosthesis
- Vision-R Knee

Nail System

- PFNA Nail System
- ZFN Multi-Purpose Femoral Nail Systems
- Femur-Tibia Arthrodesis Nail Systems
- Retrograde Femoral Nail
- ZTN Tibial Nail Systems
- Cannulated Intramedullary Humeral Nail
- Titanium Elastic Nail

External Fixation System

- External Fixator
- External Hybrid Fixator
- Small External Tubular Fixator
- Large External Tubular Fixator

- Skeletal Pin and Wires
- Spinal System
- Arthroscopy

Plate Systems

Small Fragment Locking Plate System

zimed[®]

Plate Systems & Screws

Hand Carpus (Arthrodesis) Plate with Ø 3,5 - Ø 4.0 mm screw



REF. NO	HOLES
1022-0008	8

Eight Plate with Ø 3,5 - Ø 4.0 mm screw



REF. NO	LENGTH (mm)
1872-0012	12
1872-0016	16
1872-0020	20
1872-0024	24

Arthroplasty Systems

Angled Blade Plate 90° Plate with Ø 3,5 - Ø 4.0 mm screw



REF. NO	LENGTH / HOLES (mm)
1232-2803	28/3
1232-2804	28/4
1232-2805	28/5
1232-2806	28/6
1232-2807	28/7
1232-2808	28/8
1232-3303	33/3
1232-3304	33/4
1232-3305	33/5
1232-3306	33/6
1232-3307	33/7
1232-3308	33/8
1232-3803	38/3
1232-3804	38/4
1232-3805	38/5
1232-3806	38/6
1232-3807	38/7
1232-3808	38/8

Angled Blade Plate 135° Plate with Ø 3,5 - Ø 4.0 mm screw



REF. NO	LENGTH / HOLES (mm)
1112-2803	28/3
1112-2804	28/4
1112-2805	28/5
1112-2806	28/6
1112-2807	28/7
1112-2808	28/8
1112-3303	33/3
1112-3304	33/4
1112-3305	33/5
1112-3306	33/6
1112-3307	33/7
1112-3308	33/8
1112-3803	38/3
1112-3804	38/4
1112-3805	38/5
1112-3806	38/6
1112-3807	38/7
1112-3808	38/8

Nail System

External Fixation System

- PFNA Nail System
- ZFN Multi-Purpose Femoral Nail Systems
- Femur-Tibia Arthrodesis Nail Systems
- Retrograde Femoral Nail
- ZTN Tibial Nail Systems
- Cannulated Intramedullary Humeral Nail
- Titanium Elastic Nail

- External Fixator
- External Hybrid Fixator
- Small External Tubular Fixator
- Large External Tubular Fixator

- Skeletal Pin and Wires
- Spinal System
- Arthroscopy



Plate Systems

Small Fragment Locking Plate System

Plate Systems & Screws

- Large Fragment Locking Plate System
- Large Fragment Screws
- Small Fragment Locking Plate System
- Pelvic & Acetabulum Plate System**
- Small Fragment Screw
- Cannulated Screws
- Headless Cannulated Screws
- Locking Mini Plate System
- Locking DHS-DCS Plate System

Arthroplasty Systems

- Hip Joint Prosthesis
- Revision Hip Joint Prosthesis
- Total Knee Joint Prosthesis
- Vision-R Knee

Nail System

- PFNA Nail System
- ZFN Multi-Purpose Femoral Nail Systems
- Femur-Tibia Arthrodesis Nail Systems
- Retrograde Femoral Nail
- ZTN Tibial Nail Systems
- Cannulated Intramedullary Humeral Nail
- Titanium Elastic Nail

External Fixation System

- External Fixator
- External Hybrid Fixator
- Small External Tubular Fixator
- Large External Tubular Fixator

- Skeletal Pin and Wires
- Spinal System
- Arthroscopy

Locking Straight Reconstruction Plate

with \varnothing 3,5 mm screw



REF. NO	HOLES
1422-0003	3
1422-0004	4
1422-0005	5
1422-0006	6
1422-0007	7
1422-0008	8
1422-0009	9
1422-0010	10
1422-0012	12
1422-0014	14
1422-0016	16
1422-0018	18
1422-0020	20

REF. NO	HOLES
1932-0004	4
1932-0005	5
1932-0006	6
1932-0007	7
1932-0008	8
1932-0009	9
1932-0010	10
1932-0011	11
1932-0012	12
1932-0013	13
1932-0014	14
1932-0015	15
1932-0016	16

Curved Reconstruction Plate

with \varnothing 3,5 mm screw

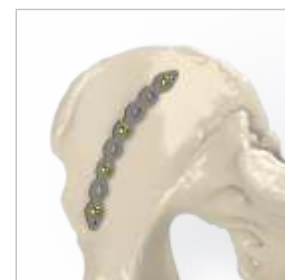

Acetabular Hook Plate

with \varnothing 3,5 mm screw



REF. NO	HOLES
9802-0002	2
9802-0003	3
9802-0004	4
9802-0005	5
9802-0006	6

Symphysis Pubis Pelvic Plate

with \varnothing 3,5 mm screw



REF. NO	HOLES	SIZE
9742-0010	4	S
9742-0030	4	M
9742-0020	4	L

Superior Sacroiliac Plate

with \varnothing 3,5 mm screw



REF. NO
9192-0010

Plate Systems

Small Fragment Locking Plate System

zimed[®]

REF. NO	HOLES
9612-1009	9-R
9612-1010	10-R
9612-2009	9-L
9612-2010	10-L

Posterior Wall Acetabular Plate
with Ø 3,5 mm screw



REF. NO	HOLES
9592-1012	12-R
9592-2012	12-L

Iliopectineal Pelvic Plate
with Ø 3,5 mm screw



Anterior Brim Pelvic Plate
with Ø 3,5 mm screw



REF. NO	HOLES
1092-1013	13-R
1092-2013	13-L



Locking Butterfly Pelvic Plate
with Ø 3,5 mm screw

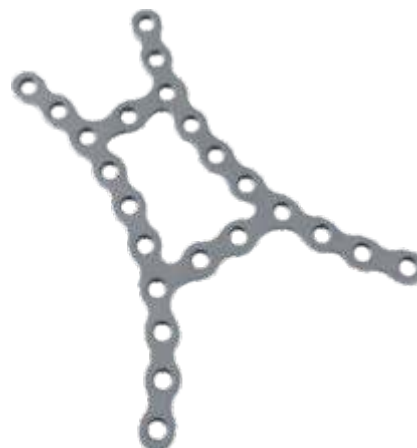

REF. NO	HOLES
1942-0023	23

Plate Systems & Screws

- Large Fragment Locking Plate System
- Large Fragment Screws
- Small Fragment Locking Plate System
- Pelvic & Acetabulum Plate System**
- Small Fragment Screw
- Cannulated Screws
- Headless Cannulated Screws
- Locking Mini Plate System
- Locking DHS-DCS Plate System

Arthroplasty Systems

- Hip Joint Prosthesis
- Revision Hip Joint Prosthesis
- Total Knee Joint Prosthesis
- Vision-R Knee

Nail System

- PFNA Nail System
- ZFN Multi-Purpose Femoral Nail Systems
- Femur-Tibia Arthrodesis Nail Systems
- Retrograde Femoral Nail
- ZTN Tibial Nail Systems
- Cannulated Intramedullary Humeral Nail
- Titanium Elastic Nail

External Fixation System

- External Fixator
- External Hybrid Fixator
- Small External Tubular Fixator
- Large External Tubular Fixator

- Skeletal Pin and Wires
- Spinal System
- Arthroscopy

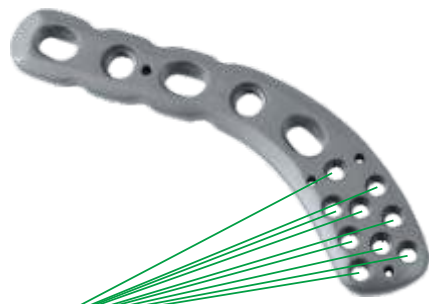

Plate Systems

Small Fragment Locking Plate System

Plate Systems & Screws

Locking Distal Clavicle Plate with Ø 3,5 - Ø 4.0 mm screw



Ø 2.4 mm Locking Screw

REF. NO	HOLES
1492-1014	14-R
1492-1017	17-R
1492-2014	14-L
1492-2017	17-L

REF. NO	HOLES
1632-1006	6-R
1632-1008	8-R
1632-1010	10-R
1632-1012	12-R
1632-2006	6-L
1632-2008	8-L
1632-2010	10-L
1632-2012	12-L

Locking Clavicle Plate

with Ø 3,5 - Ø 4.0 mm screw



Locking Clavicle Hook Plate

with Ø 3,5 - Ø 4.0 mm screw



REF. NO	HOLES
1622-1005	5-R
1622-1007	7-R
1622-1009	9-R
1622-2005	5-L
1622-2007	7-L
1622-2009	9-L

REF. NO	HOLES
1702-0020	20
1702-0022	22

Locking Pilon Plate

with Ø 3,5 - Ø 4.0 mm screw



- Large Fragment Locking Plate System
- Large Fragment Screws
- Small Fragment Locking Plate System**
- Pelvic & Acetabulum Plate System
- Small Fragment Screw
- Cannulated Screws
- Headless Cannulated Screws
- Locking Mini Plate System
- Locking DHS-DCS Plate System

- ### Arthroplasty Systems
- Hip Joint Prosthesis
 - Revision Hip Joint Prosthesis
 - Total Knee Joint Prosthesis
 - Vision-R Knee

- ### Nail System
- PFNA Nail System
 - ZFN Multi-Purpose Femoral Nail Systems
 - Femur-Tibia Arthrodesis Nail Systems
 - Retrograde Femoral Nail
 - ZTN Tibial Nail Systems
 - Cannulated Intramedullary Humeral Nail
 - Titanium Elastic Nail

- ### External Fixation System
- External Fixator
 - External Hybrid Fixator
 - Small External Tubular Fixator
 - Large External Tubular Fixator

- Skeletal Pin and Wires
- Spinal System
- Arthroscopy

Plate Systems

Small Fragment Locking Plate System



Plate Systems & Screws

Locking Distal Fibular Plate
with \varnothing 3,5 - \varnothing 4.0 mm screw



REF. NO	HOLES
1852-1009	9-R
1852-1011	11-R
1852-1013	13-R
1852-2009	9-L
1852-2011	11-L
1852-2013	13-L

REF. NO	HOLES
1842-1009	9-R
1842-1011	11-R
1842-1013	13-R
1842-1015	15-R
1842-1017	17-R
1842-2009	9-L
1842-2011	11-L
1842-2013	13-L
1842-2015	15-L
1842-2017	17-L

Locking Distal Lateral Fibular Plate
with \varnothing 3,5 - \varnothing 4.0 mm screw



\varnothing 2.4 mm Locking Screw

Arthroplasty Systems

- Hip Joint Prosthesis
- Revision Hip Joint Prosthesis
- Total Knee Joint Prosthesis
- Vision-R Knee

Nail System

- PFNA Nail System
- ZFN Multi-Purpose Femoral Nail Systems
- Femur-Tibia Arthrodesis Nail Systems
- Retrograde Femoral Nail
- ZTN Tibial Nail Systems
- Cannulated Intramedullary Humeral Nail
- Titanium Elastic Nail

Locking Calcaneal F Plate
with \varnothing 3,5 - \varnothing 4.0 mm screw



REF. NO	LENGTH (mm)
1602-1046	46-R
1602-1060	60-R
1602-1070	70-R
1602-2046	46-L
1602-2060	60-L
1602-2070	70-L

Locking Calcaneal Y Plate
with \varnothing 3,5 - \varnothing 4.0 mm screw



REF. NO	LENGTH (mm)
8862-1046	46-R
8862-1060	60-R
8862-1070	70-R
8862-2046	46-L
8862-2060	60-L
8862-2070	70-L

Locking Lateral Calcaneal Plate
with \varnothing 3,5 - \varnothing 4.0 mm screw



REF. NO	HOLES
1612-1018	18-R
1612-1020	20-R
1612-2018	18-L
1612-2020	20-L

External Fixation System

- External Fixator
- External Hybrid Fixator
- Small External Tubular Fixator
- Large External Tubular Fixator

- Skeletal Pin and Wires
- Spinal System
- Arthroscopy

Plate Systems

Small Fragment Locking Plate System

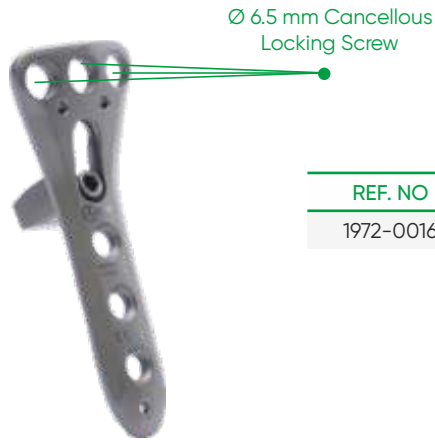

Plate Systems & Screws

- Large Fragment Locking Plate System
- Large Fragment Screws
- Small Fragment Locking Plate System**
- Pelvic & Acetabulum Plate System
- Small Fragment Screw
- Cannulated Screws
- Headless Cannulated Screws
- Locking Mini Plate System
- Locking DHS-DCS Plate System

Locking Adjustable High Tibia Osteotomy Plate Type II

with \varnothing 4.5 - \varnothing 5.0 mm screw



REF. NO
1972-0016

Locking Adjustable High Tibia Osteotomy Wedge Plate



REF. NO	LENGTH (mm)
1972-0006	6
1972-0008	8
1972-0010	10
1972-0012	12
1972-0014	14

Arthroplasty Systems

- Hip Joint Prosthesis
- Revision Hip Joint Prosthesis
- Total Knee Joint Prosthesis
- Vision-R Knee

\varnothing 6.5 mm Cancellous Locking Screw

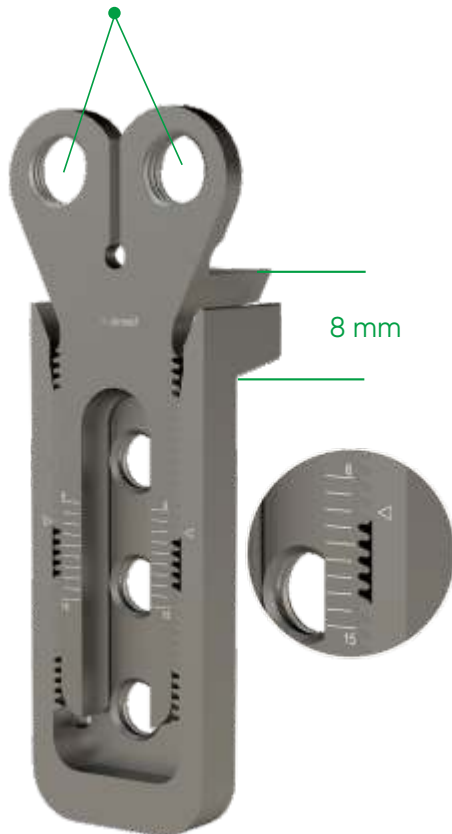

Locking Adjustable High Tibia Osteotomy Plate Type I

with \varnothing 4.5 - \varnothing 5.0 mm screw



REF. NO
1972-0015



REF. NO
1972-0020

Nail System

- PFNA Nail System
- ZFN Multi-Purpose Femoral Nail Systems
- Femur-Tibia Arthrodesis Nail Systems
- Retrograde Femoral Nail
- ZTN Tibial Nail Systems
- Cannulated Intramedullary Humeral Nail
- Titanium Elastic Nail

External Fixation System

- External Fixator
- External Hybrid Fixator
- Small External Tubular Fixator
- Large External Tubular Fixator

- Skeletal Pin and Wires
- Spinal System
- Arthroscopy



Plate Systems

Small Fragment Locking Plate System

Plate Systems & Screws

Large Fragment Locking Plate System

Large Fragment Screws

Small Fragment Locking Plate System

Pelvic & Acetabulum Plate System

Small Fragment Screw

Cannulated Screws

Headless Cannulated Screws

Locking Mini Plate System

Locking DHS-DCS Plate System

Arthroplasty Systems

Hip Joint Prosthesis

Revision Hip Joint Prosthesis

Total Knee Joint Prosthesis

Vision-R Knee

Nail System

PFNA Nail System

ZFN Multi-Purpose Femoral Nail Systems

Femur-Tibia Arthrodesis Nail Systems

Retrograde Femoral Nail

ZTN Tibial Nail Systems

Cannulated Intramedullary Humeral Nail

Titanium Elastic Nail

External Fixation System

External Fixator

External Hybrid Fixator

Small External Tubular Fixator

Large External Tubular Fixator

Skeletal Pin and Wires

Spinal System

Arthroscopy

Patella Plate



REF. NO	SIZE
1072-0001	S
1072-0002	M
1072-0003	L



Elbow (Arthrodesis) Plate

with \varnothing 3.5 - \varnothing 4.0 mm screw



REF. NO	HOLES
1222-0010	20



Screws

Small Fragment Locking Plate System



Plate Systems & Screws

- Large Fragment Locking Plate System
- Large Fragment Screws
- Small Fragment Locking Plate System
- Pelvic & Acetabulum Plate System
- Small Fragment Screw**
- Cannulated Screws
- Headless Cannulated Screws
- Locking Mini Plate System
- Locking DHS-DCS Plate System

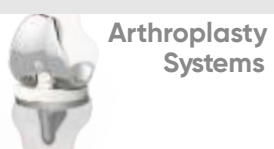

Arthroplasty Systems

- Hip Joint Prosthesis
- Revision Hip Joint Prosthesis
- Total Knee Joint Prosthesis
- Vision-R Knee



Nail System

- PFNA Nail System
- ZFN Multi-Purpose Femoral Nail Systems
- Femur-Tibia Arthrodesis Nail Systems
- Retrograde Femoral Nail
- ZTN Tibial Nail Systems
- Cannulated Intramedullary Humeral Nail
- Titanium Elastic Nail

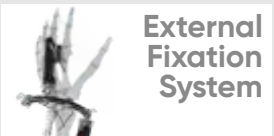

External Fixation System

- External Fixator
- External Hybrid Fixator
- Small External Tubular Fixator
- Large External Tubular Fixator

- Skeletal Pin and Wires
- Spinal System
- Arthroscopy

Locking Screw (Ø 3.5 mm)



REF. NO	LENGTH (mm)
2052-3512	12
2052-3514	14
2052-3516	16
2052-3518	18
2052-3520	20
2052-3522	22
2052-3524	24
2052-3526	26
2052-3528	28
2052-3530	30
2052-3532	32
2052-3534	34
2052-3536	36
2052-3538	38
2052-3540	40
2052-3542	42
2052-3544	44
2052-3546	46
2052-3548	48
2052-3550	50
2052-3555	55
2052-3560	60
2052-3565	65
2052-3570	70

Locking Cannulated Screws (Ø 3.5 mm)



REF. NO	LENGTH (mm)
2412-3512	12
2412-3514	14
2412-3516	16
2412-3518	18
2412-3520	20
2412-3522	22
2412-3524	24
2412-3526	26
2412-3528	28
2412-3530	30
2412-3532	32
2412-3534	34
2412-3536	36
2412-3538	38
2412-3540	40
2412-3542	42
2412-3544	44
2412-3546	46
2412-3548	48
2412-3550	50
2412-3555	55

Locking Cancellous Screw (Ø 4.0 mm)



REF. NO	LENGTH (mm)
2152-4012	12
2152-4014	14
2152-4016	16
2152-4018	18
2152-4020	20
2152-4022	22
2152-4024	24
2152-4026	26
2152-4028	28
2152-4030	30
2152-4032	32
2152-4034	34
2152-4036	36
2152-4038	38
2152-4040	40
2152-4042	42
2152-4044	44
2152-4046	46
2152-4048	48
2152-4050	50

Cable Adapter Locking Screw



REF. NO	LENGTH (mm)
2602-3500	3.5

Locking Screw Plug



REF. NO	LENGTH (mm)
2052-3500	3.5

Screws

Small Fragment Locking Plate System

zimed[®]

Plate Systems & Screws

- Large Fragment Locking Plate System
- Large Fragment Screws
- Small Fragment Locking Plate System
- Pelvic & Acetabulum Plate System
- Small Fragment Screw**
- Cannulated Screws
- Headless Cannulated Screws
- Locking Mini Plate System
- Locking DHS-DCS Plate System

Arthroplasty Systems

- Hip Joint Prosthesis
- Revision Hip Joint Prosthesis
- Total Knee Joint Prosthesis
- Vision-R Knee

Nail System

- PFNA Nail System
- ZFN Multi-Purpose Femoral Nail Systems
- Femur-Tibia Arthrodesis Nail Systems
- Retrograde Femoral Nail
- ZTN Tibial Nail Systems
- Cannulated Intramedullary Humeral Nail
- Titanium Elastic Nail

External Fixation System

- External Fixator
- External Hybrid Fixator
- Small External Tubular Fixator
- Large External Tubular Fixator

- Skeletal Pin and Wires
- Spinal System
- Arthroscopy

Cancellous Screw (Ø 4.0 mm) (1/3 mm Threaded)



REF. NO	LENGTH (mm)
2932-4012	12
2932-4014	14
2932-4016	16
2932-4018	18
2932-4020	20
2932-4022	22
2932-4024	24
2932-4026	26
2932-4028	28
2932-4030	30
2932-4032	32
2932-4034	34
2932-4036	36
2932-4038	38
2932-4040	40
2932-4042	42
2932-4044	44
2932-4046	46
2932-4048	48
2932-4050	50

Cortical Screw (Ø 3.5 mm)



REF. NO	LENGTH (mm)
2012-3512	12
2012-3514	14
2012-3516	16
2012-3518	18
2012-3520	20
2012-3522	22
2012-3524	24
2012-3526	26
2012-3528	28
2012-3530	30
2012-3532	32
2012-3534	34
2012-3536	36
2012-3538	38
2012-3540	40
2012-3542	42
2012-3544	44
2012-3546	46
2012-3548	48
2012-3550	50
2012-3552	52
2012-3555	55
2012-3560	60
2012-3565	65
2012-3570	70
2012-3575	75
2012-3580	80
2012-3585	85
2012-3590	90
2012-3595	95
2012-3100	100
2012-3105	105
2012-3110	110
2012-3115	115
2012-3120	120



Screws

Small Fragment Locking Plate System

Plate Systems & Screws

Cortical Screw (Ø 2.4 mm)



REF. NO	LENGTH (mm)
2072-2410	10
2072-2412	12
2072-2414	14
2072-2416	16
2072-2418	18
2072-2420	20
2072-2422	22
2072-2424	24
2072-2426	26
2072-2428	28
2072-2430	30

Locking Screws (Ø 2.4 mm)



REF. NO	LENGTH (mm)
2342-2410	10
2342-2412	12
2342-2414	14
2342-2416	16
2342-2418	18
2342-2420	20
2342-2422	22
2342-2424	24
2342-2426	26
2342-2428	28
2342-2430	30

Malleolar Screws (Ø 4.5 mm)



REF. NO	LENGTH (mm)
2092-0025	25
2092-0030	30
2092-0035	35
2092-0040	40
2092-0045	45
2092-0050	50
2092-0055	55
2092-0060	60
2092-0065	65
2092-0070	70
2092-0075	75
2092-0080	80
2092-0085	85

Arthroplasty Systems

- Hip Joint Prosthesis
- Revision Hip Joint Prosthesis
- Total Knee Joint Prosthesis
- Vision-R Knee

Nail System

- PFNA Nail System
- ZFN Multi-Purpose Femoral Nail Systems
- Femur-Tibia Arthrodesis Nail Systems
- Retrograde Femoral Nail
- ZTN Tibial Nail Systems
- Cannulated Intramedullary Humeral Nail
- Titanium Elastic Nail

External Fixation System

- External Fixator
- External Hybrid Fixator
- Small External Tubular Fixator
- Large External Tubular Fixator

- Skeletal Pin and Wires
- Spinal System
- Arthroscopy



Screws

Cannulated Screws/Herbert Compression Screws

Plate Systems & Screws

- Large Fragment Locking Plate System
- Large Fragment Screws
- Small Fragment Locking Plate System
- Pelvic & Acetabulum Plate System
- Small Fragment Screw
- Cannulated Screws**
- Headless Cannulated Screws
- Locking Mini Plate System
- Locking DHS-DCS Plate System

Arthroplasty Systems

- Hip Joint Prosthesis
- Revision Hip Joint Prosthesis
- Total Knee Joint Prosthesis
- Vision-R Knee

Nail System

- PFNA Nail System
- ZFN Multi-Purpose Femoral Nail Systems
- Femur-Tibia Arthrodesis Nail Systems
- Retrograde Femoral Nail
- ZTN Tibial Nail Systems
- Cannulated Intramedullary Humeral Nail
- Titanium Elastic Nail

External Fixation System

- External Fixator
- External Hybrid Fixator
- Small External Tubular Fixator
- Large External Tubular Fixator

- Skeletal Pin and Wires
- Spinal System
- Arthroscopy



Cannulated Screws (Ø 3.5 mm)



REF. NO	LENGTH (mm)
2162-0012	12
2162-0014	14
2162-0016	16
2162-0018	18
2162-0020	20
2162-0022	22
2162-0024	24
2162-0026	26
2162-0028	28
2162-0030	30
2162-0032	32
2162-0034	34
2162-0036	36
2162-0038	38
2162-0040	40
2162-0042	42
2162-0044	44
2162-0046	46
2162-0048	48
2162-0050	50

Washer

Ø7.3 mm - Ø4.5 mm - Ø3.5 mm



REF. NO	LENGTH (mm)
2012-0035	3.5
2012-0045	4.5
2042-0073	7.3

Cannulated Screws (Ø 4.5 mm)



REF. NO	LENGTH (mm)
2032-0022	22
2032-0024	24
2032-0026	26
2032-0028	28
2032-0030	30
2032-0032	32
2032-0034	34
2032-0036	36
2032-0038	38
2032-0040	40
2032-0042	42
2032-0044	44
2032-0046	46
2032-0048	48
2032-0050	50
2032-0052	52
2032-0054	54
2032-0056	56
2032-0058	58
2032-0060	60

Cannulated Screws (Ø 7.3 mm) (16 mm Threaded)



REF. NO	LENGTH (mm)
2042-0050	50
2042-0055	55
2042-0060	60
2042-0065	65
2042-0070	70
2042-0075	75
2042-0080	80
2042-0085	85
2042-0090	90
2042-0095	95
2042-0100	100
2042-0105	105
2042-0110	110
2042-0115	115
2042-0120	120

Cannulated Screws (Ø 7.3 mm) (32 mm Threaded)



REF. NO	LENGTH (mm)
2252-0050	50
2252-0055	55
2252-0060	60
2252-0065	65
2252-0070	70
2252-0075	75
2252-0080	80
2252-0085	85
2252-0090	90
2252-0095	95
2252-0100	100
2252-0105	105
2252-0110	110
2252-0115	115
2252-0120	120

Cannulated Herbert Screws (Ø 3.0 mm)



REF. NO	LENGTH (mm)
2172-0010	10
2172-0012	12
2172-0014	14
2172-0016	16
2172-0018	18
2172-0020	20
2172-0022	22
2172-0024	24
2172-0026	26
2172-0028	28
2172-0030	30

Screws

Cannulated Headless Screw



Plate Systems & Screws

- Large Fragment Locking Plate System
- Large Fragment Screws
- Small Fragment Locking Plate System
- Pelvic & Acetabulum Plate System
- Small Fragment Screw
- Cannulated Screws
- Headless Cannulated Screws**
- Locking Mini Plate System
- Locking DHS-DCS Plate System

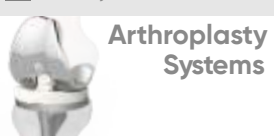

Arthroplasty Systems

- Hip Joint Prosthesis
- Revision Hip Joint Prosthesis
- Total Knee Joint Prosthesis
- Vision-R Knee

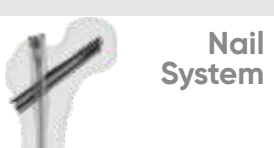

Nail System

- PFNA Nail System
- ZFN Multi-Purpose Femoral Nail Systems
- Femur-Tibia Arthrodesis Nail Systems
- Retrograde Femoral Nail
- ZTN Tibial Nail Systems
- Cannulated Intramedullary Humeral Nail
- Titanium Elastic Nail

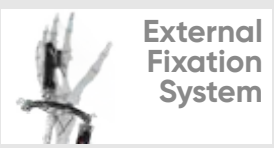

External Fixation System

- External Fixator
- External Hybrid Fixator
- Small External Tubular Fixator
- Large External Tubular Fixator

- Skeletal Pin and Wires
- Spinal System
- Arthroscopy

Headless Cannulated Screws (Ø 2.5 mm)

REF. NO	LENGTH (mm)
2362-2508	8
2362-2510	10
2362-2512	12
2362-2514	14
2362-2516	16
2362-2518	18
2362-2520	20



Headless Cannulated Screws (Ø 3.5 mm)

REF. NO	LENGTH (mm)
2362-3516	16
2362-3518	18
2362-3520	20
2362-3522	22
2362-3524	24
2362-3526	26
2362-3528	28
2362-3530	30
2362-3532	32
2362-3534	34
2362-3536	36
2362-3538	38
2362-3540	40



Headless Cannulated Screws (Ø 4.0 mm)

REF. NO	LENGTH (mm)
2362-4016	16
2362-4018	18
2362-4020	20
2362-4022	22
2362-4024	24
2362-4026	26
2362-4028	28
2362-4030	30
2362-4032	32
2362-4034	34
2362-4036	36
2362-4038	38
2362-4040	40



Headless Cannulated Screws (Ø 5.0 mm)

REF. NO	LENGTH (mm)
2362-5025	25
2362-5030	30
2362-5035	35
2362-5040	40
2362-5045	45
2362-5050	50



Headless Cannulated Screws (Ø 6.5 mm)

REF. NO	LENGTH (mm)
2362-6035	35
2362-6040	40
2362-6045	45
2362-6050	50
2362-6055	55
2362-6060	60
2362-6065	65
2362-6070	70
2362-6075	75
2362-6080	80
2362-6085	85
2362-6090	90
2362-6095	95





Plate Systems

Locking Mini Plate Systems

Plate Systems & Screws

- Large Fragment Locking Plate System
- Large Fragment Screws
- Small Fragment Locking Plate System
- Pelvic & Acetabulum Plate System
- Small Fragment Screw
- Cannulated Screws
- Headless Cannulated Screws
- Locking Mini Plate System**
- Locking DHS-DCS Plate System

Arthroplasty Systems

- Hip Joint Prosthesis
- Revision Hip Joint Prosthesis
- Total Knee Joint Prosthesis
- Vision-R Knee

Nail System

- PFNA Nail System
- ZFN Multi-Purpose Femoral Nail Systems
- Femur-Tibia Arthrodesis Nail Systems
- Retrograde Femoral Nail
- ZTN Tibial Nail Systems
- Cannulated Intramedullary Humeral Nail
- Titanium Elastic Nail

External Fixation System

- External Fixator
- External Hybrid Fixator
- Small External Tubular Fixator
- Large External Tubular Fixator

- Skeletal Pin and Wires
- Spinal System
- Arthroscopy

Locking LCP Straight Plate 2.0 mm



REF. NO	HOLES
OP.1012-0004	4
OP.1012-0005	5
OP.1012-0006	6
OP.1012-0007	7
OP.1012-0008	8

Locking LCP T Plate Type-I 2.0 mm



REF. NO	HOLES
OP.1032-0023	2+3
OP.1032-0025	2+5
OP.1032-0027	2+7

Locking LCP T Plate 2.0 mm



REF. NO	HOLES
OP.1052-0033	3+3
OP.1052-0035	3+5
OP.1052-0037	3+7

Locking LCP Y Plate 2.0 mm



REF. NO	HOLES
OP.1062-0033	3+3
OP.1062-0035	3+5
OP.1062-0037	3+7

Cortex Screw Ø 2.0 mm



REF. NO	LENGTH (mm)
OS.2012-2006	6
OS.2012-2007	7
OS.2012-2008	8
OS.2012-2009	9
OS.2012-2010	10
OS.2012-2011	11
OS.2012-2012	12
OS.2012-2013	13
OS.2012-2014	14
OS.2012-2015	15
OS.2012-2016	16
OS.2012-2017	17
OS.2012-2018	18
OS.2012-2019	19
OS.2012-2020	20
OS.2012-2022	22
OS.2012-2024	24
OS.2012-2026	26
OS.2012-2028	28
OS.2012-2030	30

Locking Screw Ø 2.0 mm



REF. NO	LENGTH (mm)
OS.2022-2006	6
OS.2022-2007	7
OS.2022-2008	8
OS.2022-2009	9
OS.2022-2010	10
OS.2022-2011	11
OS.2022-2012	12
OS.2022-2013	13
OS.2022-2014	14
OS.2022-2015	15
OS.2022-2016	16
OS.2022-2017	17
OS.2022-2018	18
OS.2022-2019	19
OS.2022-2020	20
OS.2022-2022	22
OS.2022-2024	24
OS.2022-2026	26
OS.2022-2028	28
OS.2022-2030	30

Locking LCP T Plate Type-II 2.0 mm



REF. NO	HOLES
OP.1042-0023	2+3
OP.1042-0025	2+5
OP.1042-0027	2+7

Locking LCP Reconstruction Plate 2.0 mm



REF. NO	HOLES
OP.1022-0006	6
OP.1022-0012	12

Plate Systems

Locking Mini Plate Systems



Plate Systems & Screws

- Large Fragment Locking Plate System
- Large Fragment Screws
- Small Fragment Locking Plate System
- Pelvic & Acetabulum Plate System
- Small Fragment Screw
- Cannulated Screws
- Headless Cannulated Screws
- Locking Mini Plate System**
- Locking DHS-DCS Plate System

Locking LCP Straight Plate
2.4 mm



REF. NO	HOLES
OP.1072-0004	4
OP.1072-0005	5
OP.1072-0006	6
OP.1072-0007	7
OP.1012-0008	8
OP.1072-0010	10

T Phalange Plate Type-I
2.4 mm



REF. NO	HOLES
OP.1092-0023	2+3
OP.1092-0025	2+5
OP.1092-0027	2+7

Locking LCP T Plate
2.4 mm



REF. NO	HOLES
OP.1112-0033	3+3
OP.1112-0035	3+5
OP.1112-0037	3+7

Arthroplasty Systems

- Hip Joint Prosthesis
- Revision Hip Joint Prosthesis
- Total Knee Joint Prosthesis
- Vision-R Knee

Locking LCP Y Plate
2.4 mm



REF. NO	HOLES
OP.1122-0033	3+3
OP.1122-0035	3+5
OP.1122-0037	3+7

Cortex Screw
Ø 2.4 mm



REF. NO	LENGTH (mm)
OS.2032-2406	6
OS.2032-2407	7
OS.2032-2408	8
OS.2032-2409	9
OS.2032-2410	10
OS.2032-2411	11
OS.2032-2412	12
OS.2032-2413	13
OS.2032-2414	14
OS.2032-2415	15
OS.2032-2416	16
OS.2032-2417	17
OS.2032-2418	18
OS.2032-2419	19
OS.2032-2420	20
OS.2032-2422	22
OS.2032-2424	24
OS.2032-2426	26
OS.2032-2428	28
OS.2032-2430	30

Locking Screw
Ø 2.4 mm



REF. NO	LENGTH (mm)
OS.2042-2406	6
OS.2042-2407	7
OS.2042-2408	8
OS.2042-2409	9
OS.2042-2410	10
OS.2042-2411	11
OS.2042-2412	12
OS.2042-2413	13
OS.2042-2414	14
OS.2042-2415	15
OS.2042-2416	16
OS.2042-2417	17
OS.2042-2418	18
OS.2042-2419	19
OS.2042-2420	20
OS.2042-2422	22
OS.2042-2424	24
OS.2042-2426	26
OS.2042-2428	28
OS.2042-2430	30

Nail System

- PFNA Nail System
- ZFN Multi-Purpose Femoral Nail Systems
- Femur-Tibia Arthrodesis Nail Systems
- Retrograde Femoral Nail
- ZTN Tibial Nail Systems
- Cannulated Intramedullary Humeral Nail
- Titanium Elastic Nail

T Phalange Plate Type-II
2.4 mm



REF. NO	HOLES
OP.1102-0023	2+3
OP.1102-0025	2+5
OP.1102-0027	2+7

Locking LCP Straight Reconstruction Plate
2.4 mm



REF. NO	HOLES
OP.1082-0006	6
OP.1082-0012	12

External Fixation System

- External Fixator
- External Hybrid Fixator
- Small External Tubular Fixator
- Large External Tubular Fixator

- Skeletal Pin and Wires
- Spinal System
- Arthroscopy

Plate Systems

Locking DHS-DCS Plates



Plate Systems & Screws

Locking DHS Plate 135°

with Ø 5.0 - Ø 4.5 - Ø 6.5 mm screw



REF. NO	HOLES
1732-0002	2
1732-0003	3
1732-0004	4
1732-0005	5
1732-0006	6
1732-0007	7
1732-0008	8
1732-0009	9
1732-0010	10
1732-0011	11
1732-0012	12
1732-0014	14
1732-0015	15
1732-0016	16

Locking DCS Plate 95°

with Ø 5.0 - Ø 4.5 - Ø 6.5 mm screw



REF. NO	HOLES
1742-0003	3
1742-0004	4
1742-0005	5
1742-0006	6
1742-0007	7
1742-0008	8
1742-0009	9
1742-0010	10
1742-0011	11
1742-0012	12
1742-0013	13
1742-0014	14
1742-0016	16

Arthroplasty Systems

- Hip Joint Prosthesis
- Revision Hip Joint Prosthesis
- Total Knee Joint Prosthesis
- Vision-R Knee

Nail System

DHS / DCS Lag Screw

REF. NO	LENGTH (mm)
1062-0050	50
1062-0055	55
1062-0060	60
1062-0065	65
1062-0070	70
1062-0075	75
1062-0080	80
1062-0085	85
1062-0090	90
1062-0095	95
1062-0100	100
1062-0105	105
1062-0110	110
1062-0115	115



DHS/DCS Lag Compression Screw

REF. NO
1772-0000



External Fixation System

- External Fixator
- External Hybrid Fixator
- Small External Tubular Fixator
- Large External Tubular Fixator

- Skeletal Pin and Wires
- Spinal System
- Arthroscopy





Plate Systems

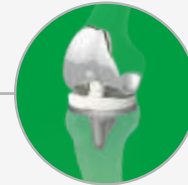

Arthroplasty Systems⁺

Hip Joint Prosthesis	34
Revision Hip Joint Prosthesis	37
Total Knee Joint Prosthesis	39
Vision-R Knee	42



Nail Systems



External Fixation Systems

Skeletal Pins and Wires

Spinal Systems

Arthroscopy

ROPLASTY



Arthroplasty Systems

Hip Joint Prosthesis

Plate Systems & Screws

- Large Fragment Locking Plate System
- Large Fragment Screws
- Small Fragment Locking Plate System
- Pelvic & Acetabulum Plate System
- Small Fragment Screw
- Cannulated Screws
- Headless Cannulated Screws
- Locking Mini Plate System
- Locking DHS-DCS Plate System

Arthroplasty Systems

- Hip Joint Prosthesis**
- Revision Hip Joint Prosthesis
- Total Knee Joint Prosthesis
- Vision-R Knee

Nail System

- PFNA Nail System
- ZFN Multi-Purpose Femoral Nail Systems
- Femur-Tibia Arthrodesis Nail Systems
- Retrograde Femoral Nail
- ZTN Tibial Nail Systems
- Cannulated Intramedullary Humeral Nail
- Titanium Elastic Nail

External Fixation System

- External Fixator
- External Hybrid Fixator
- Small External Tubular Fixator
- Large External Tubular Fixator

- Skeletal Pin and Wires
- Spinal System
- Arthroscopy

Calcar Replacement Sandblasting Stem (Cemented)



REF. NO (SS)	REF. NO (CoCrMo Alloy)	SIZE (mm)
7031-0251	7033-0251	25-9
7031-0252	7033-0252	25-11
7031-0253	7033-0253	25-13
7031-0351	7033-0351	35-09
7031-0352	7033-0352	35-11
7031-0353	7033-0353	35-13
-	7033-0355	35-15
-	7033-0356	35-16
-	7033-0357	35-17
7031-0451	7033-0451	45-09
7031-0452	7033-0452	45-11
7031-0453	7033-0453	45-13
7031-0551	7033-0551	55-09
7031-0552	7033-0552	55-11
7031-0553	7033-0553	55-13

Calcar Replacement Stem Dual Coated (Cementless)



REF. NO (CoCrMo Alloy)	SIZE (mm)
7033-3251	25/9
7033-3252	25/11
7033-3253	25/13
7033-3351	35/9
7033-3352	35/11
7033-3353	35/13
7033-3355	35/15
7033-3356	35/16
7033-3357	35/17
7033-3451	45/9
7033-3452	45/11
7033-3453	45/13
7033-3551	55/9
7033-3552	55/11
7033-3553	55/13

Femoral Stem (Cemented)



REF. NO (SS)	REF. NO (CoCrMo Alloy)	SIZE (mm)
7021-0700	7023-0700	7
7021-0800	7023-0800	8
7021-0900	7023-0900	9
7021-1000	7023-1000	10
7021-1100	7023-1100	11
7021-1200	7023-1200	12

Femoral Stem Dual Coated (Cementless)



REF. NO (Ti)	SIZE (mm)
7022-4075	7.5
7022-4085	8.5
7022-4090	9
7022-4100	10
7022-4110	11
7022-4120	12
7022-4135	13.5

Distal Centralizer



REF. NO (UHMWPE)	SIZE
7079-0003	S
7079-0004	M

Cement Plug



REF. NO (UHMWPE)	SIZE (mm)
7069-0009	9
7069-0010	10
7069-0011	11
7069-0012	12
7069-0013	13
7069-0014	14
7069-0015	15
7069-0016	16
7069-0017	17
7069-0018	18

Arthroplasty Systems

Hip Joint Prosthesis



Plate Systems & Screws

- Large Fragment Locking Plate System
- Large Fragment Screws
- Small Fragment Locking Plate System
- Pelvic & Acetabulum Plate System
- Small Fragment Screw
- Cannulated Screws
- Headless Cannulated Screws
- Locking Mini Plate System
- Locking DHS-DCS Plate System

Arthroplasty Systems

- Hip Joint Prosthesis
- Revision Hip Joint Prosthesis
- Total Knee Joint Prosthesis
- Vision-R Knee

Nail System

- PFNA Nail System
- ZFN Multi-Purpose Femoral Nail Systems
- Femur-Tibia Arthrodesis Nail Systems
- Retrograde Femoral Nail
- ZTN Tibial Nail Systems
- Cannulated Intramedullary Humeral Nail
- Titanium Elastic Nail

External Fixation System

- External Fixator
- External Hybrid Fixator
- Small External Tubular Fixator
- Large External Tubular Fixator

- Skeletal Pin and Wires
- Spinal System
- Arthroscopy

Acetabular Cup Dual Coated (Cementless)



REF. NO (Ti)	SIZE
7132-0042	42
7132-0044	44
7132-0046	46
7132-0048	48
7132-0050	50
7132-0052	52
7132-0054	54
7132-0056	56
7132-0058	58
7132-0060	60
7132-0062	62

Acetabular Cup Poros Coated (Cementless)



REF. NO (Ti)	SIZE
7112-0042	42
7112-0044	44
7112-0046	46
7112-0048	48
7112-0050	50
7112-0052	52
7112-0054	54
7112-0056	56
7112-0058	58
7112-0060	60
7112-0062	62

Acetabular Liner (10°)



REF. NO (UHMWPE)	SIZE	REF. NO (UHMWPE)	SIZE
7159-0042	42/22	7159-5232	52/32
7159-0044	44/22	7159-5432	54/32
7159-0046	46/22	7159-5632	56/32
7159-0048	48/28	7159-5832	58/32
7159-0050	50/28	7159-6032	60/32
7159-0052	52/28	7159-6232	62/32
7159-0054	54/28	7159-5636	56/36
7159-0056	56/28	7159-5836	58/36
7159-0058	58/28	7159-6036	60/36
7159-0060	60/28	7159-6236	62/36
7159-0062	62/28		

Acetabular Screw



REF. NO (Ti)	LENGTH (mm)
7102-0015	15
7102-0020	20
7102-0025	25
7102-0030	30
7102-0035	35
7102-0040	40
7102-0045	45

Acetabular Cup (Cemented) (10°)



REF. NO (UHMWPE)	SIZE	REF. NO (UHMWPE)	SIZE
7149-0042	42/28	7149-5036	50/36
7149-0044	44/28	7149-5236	52/36
7149-0046	46/28	7149-5436	54/36
7149-0048	48/28	7149-5636	56/36
7149-0050	50/28	7149-5836	58/36
7149-0052	52/28	7149-6036	60/36
7149-0054	54/28	7149-6236	62/36
7149-0056	56/28		
7149-0058	58/28		
7149-0060	60/28		
7149-0062	62/28		

Bipolar Head



REF. NO (SS)	REF. NO (CoCrMo Alloy)	SIZE	REF. NO (SS)	REF. NO (CoCrMo Alloy)	SIZE
7051-2238	7053-2238	38/22	7051-2850	7053-2850	50/28
7051-2840	7053-2840	40/28	7051-2852	7053-2852	52/28
7051-2842	7053-2842	42/28	7051-2854	7053-2854	54/28
7051-2844	7053-2844	44/28	7051-2856	7053-2856	56/28
7051-2846	7053-2846	46/28	7051-2858	7053-2858	58/28
7051-2848	7053-2848	48/28			



Arthroplasty Systems

Hip Joint Prosthesis

Plate Systems & Screws

- Large Fragment Locking Plate System
- Large Fragment Screws
- Small Fragment Locking Plate System
- Pelvic & Acetabulum Plate System
- Small Fragment Screw
- Cannulated Screws
- Headless Cannulated Screws
- Locking Mini Plate System
- Locking DHS-DCS Plate System

Femoral Head Modular Ø 22 mm
12/14 mm



REF. NO (SS)	REF. NO (CoCrMo Alloy)	SIZE
7041-0220	7043-0220	22+0 (M)
7041-0224	7043-0224	22+4 (L)

Femoral Head Modular Ø 28 mm
12/14 mm



REF. NO (SS)	REF. NO (CoCrMo Alloy)	SIZE
7041-0283	7043-0283	28-3 (S)
7041-0280	7043-0280	28+0 (M)
7041-0284	7043-0284	28+4 (L)
7041-0286	7043-0286	28+6 (XL)
7041-0288	7043-0288	28+8 (XXL)

Femoral Head Modular Ø 32 mm
12/14 mm



REF. NO (SS)	REF. NO (CoCrMo Alloy)	SIZE
7041-0323	7043-0323	32-3 (S)
7041-0320	7043-0320	32+0 (M)
7041-0324	7043-0324	32+4 (L)
7041-0326	7043-0326	32+6 (XL)
7041-0328	7043-0328	32+8 (XXL)

Arthroplasty Systems

- Hip Joint Prosthesis
- Revision Hip Joint Prosthesis
- Total Knee Joint Prosthesis
- Vision-R Knee

Femoral Head Modular Ø 36 mm
12/14 mm



REF. NO (SS)	REF. NO (CoCrMo Alloy)	SIZE
7041-0363	7043-0363	36-3 (S)
7041-0360	7043-0360	36+0 (M)
7041-0364	7043-0364	36+4 (L)
7041-0366	7043-0366	36+6 (XL)
7041-0368	7043-0368	36+8 (XXL)

Nail System

- PFNA Nail System
- ZFN Multi-Purpose Femoral Nail Systems
- Femur-Tibia Arthrodesis Nail Systems
- Retrograde Femoral Nail
- ZTN Tibial Nail Systems
- Cannulated Intramedullary Humeral Nail
- Titanium Elastic Nail



Throchanteric Grip

REF. NO (Ti)	SIZE
1712-0001	S 1H
1712-0002	M 3H
1712-0003	L 5H

Cable

REF. NO (SS)	REF. NO (Ti)	REF. NO (CoCrMo Alloy)	SIZE (mm)
6081-2050	6082-2050	6083-2050	2.0X500
6081-2070	6082-2070	6083-2070	2.0X700



External Fixation System

- External Fixator
- External Hybrid Fixator
- Small External Tubular Fixator
- Large External Tubular Fixator
- Skeletal Pin and Wires
- Spinal System
- Arthroscopy



Arthroplasty Systems

Revision Hip Prosthesis

Plate Systems & Screws

- Large Fragment Locking Plate System
- Large Fragment Screws
- Small Fragment Locking Plate System
- Pelvic & Acetabulum Plate System
- Small Fragment Screw
- Canulated Screws
- Headless Canulated Screws
- Locking Mini Plate System
- Locking DHS-DCS Plate System

Arthroplasty Systems

- Hip Joint Prosthesis
- Revision Hip Joint Prosthesis**
- Total Knee Joint Prosthesis
- Vision-R Knee

Nail System

- PFNA Nail System
- ZFN Multi-Purpose Femoral Nail Systems
- Femur-Tibia Arthrodesis Nail Systems
- Retrograde Femoral Nail
- ZTN Tibial Nail Systems
- Canulated Intramedullary Humeral Nail
- Titanium Elastic Nail

External Fixation System

- External Fixator
- External Hybrid Fixator
- Small External Tubular Fixator
- Large External Tubular Fixator

- Skeletal Pin and Wires
- Spinal System
- Arthroscopy



1 Revision Modular Straight Sandblasting Stem (Cementless)

REF. NO (TI)	SIZE
R.7232-1212	12/120mm
R.7232-1312	13/120mm
R.7232-1412	14/120mm
R.7232-1512	15/120mm
R.7232-1612	16/120mm
R.7232-1712	17/120mm
R.7232-1812	18/120mm
R.7232-1912	19/120mm
R.7232-2012	20/120mm
R.7232-2112	21/120mm
R.7232-2212	22/120mm
R.7232-2312	23/120mm
R.7232-2412	24/120mm

2 Revision Modular Straight Dual Coated Stem (Cementless)

REF. NO (TI)	SIZE
R.7182-1212	12/120mm
R.7182-1312	13/120mm
R.7182-1412	14/120mm
R.7182-1512	15/120mm
R.7182-1612	16/120mm
R.7182-1712	17/120mm
R.7182-1812	18/120mm
R.7182-1912	19/120mm
R.7182-2012	20/120mm
R.7182-2112	21/120mm
R.7182-2212	22/120mm
R.7182-2312	23/120mm
R.7182-2412	24/120mm

3 Revision Modular Proximal Body Sandblasting (Cementless)

REF. NO (TI)	SIZE
R.7302-2070	20/70mm
R.7302-2080	20/80mm
R.7302-2090	20/90mm
R.7302-2010	20/100mm
R.7302-2011	20/110mm
R.7302-2370	23/70mm
R.7302-2380	23/80mm
R.7302-2390	23/90mm
R.7302-2310	23/100mm
R.7302-2311	23/110mm

4 Revision Modular Proximal Body Dual Coated (Cementless)

REF. NO (TI)	SIZE
R.7272-2070	20/70mm
R.7272-2080	20/80mm
R.7272-2090	20/90mm
R.7272-2010	20/100mm
R.7272-2011	20/110mm
R.7272-2370	23/70mm
R.7272-2380	23/80mm
R.7272-2390	23/90mm
R.7272-2310	23/100mm
R.7272-2311	23/110mm

5 Revision Modular Stem Locking Screw

REF. NO (TI)	SIZE
R.7212-0070	70mm
R.7212-0080	80mm
R.7212-0090	90mm
R.7212-0100	100mm
R.7212-0110	110mm

Arthroplasty Systems

Revision Hip Prosthesis



Plate Systems & Screws

- Large Fragment Locking Plate System
- Large Fragment Screws
- Small Fragment Locking Plate System
- Pelvic & Acetabulum Plate System
- Small Fragment Screw
- Cannulated Screws
- Headless Cannulated Screws
- Locking Mini Plate System
- Locking DHS-DCS Plate System

Arthroplasty Systems

- Hip Joint Prosthesis
- Revision Hip Joint Prosthesis**
- Total Knee Joint Prosthesis
- Vision-R Knee

Nail System

- PFNA Nail System
- ZFN Multi-Purpose Femoral Nail Systems
- Femur-Tibia Arthrodesis Nail Systems
- Retrograde Femoral Nail
- ZTN Tibial Nail Systems
- Cannulated Intramedullary Humeral Nail
- Titanium Elastic Nail

External Fixation System

- External Fixator
- External Hybrid Fixator
- Small External Tubular Fixator
- Large External Tubular Fixator

- Skeletal Pin and Wires
- Spinal System
- Arthroscopy

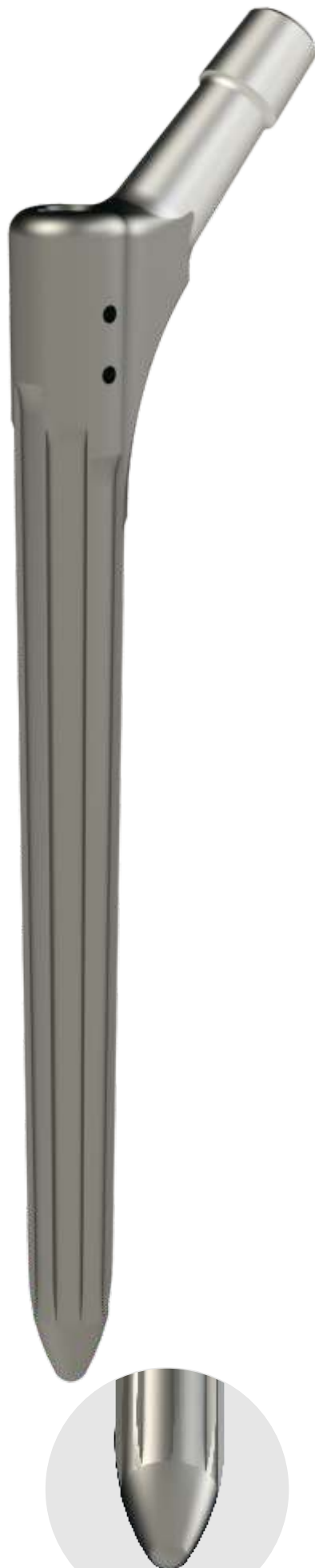

Revision Monoblock Femoral Stem (Cementless)

REF. NO (Ti)	Size	REF. NO (Ti)	Size
R.7462-0010	10mm	R.7462-0014	14mm
R.7462-0011	11mm	R.7462-0015	15mm
R.7462-0012	12mm	R.7462-0016	16mm
R.7462-0013	13mm		

Acetabular Cage

REF. NO (Ti)	Size
* R.7582-0044	44mm
* R.7582-0046	46mm
* R.7582-0048	48mm
R.7582-0050	50mm
* R.7582-0052	52mm
* R.7582-0054	54mm
R.7582-0056	56mm
* R.7582-0058	58mm
* R.7582-0060	60mm
R.7582-0062	62mm



Short / Right

REF. NO (Ti)	Size
* R.7572-1044	44mm
* R.7572-1046	46mm
* R.7572-1048	48mm
R.7572-1050	50mm
* R.7572-1052	52mm
* R.7572-1054	54mm
R.7572-1056	56mm
* R.7572-1058	58mm
* R.7572-1060	60mm
R.7572-1062	62mm

Short / Left

REF. NO (Ti)	Size
* R.7572-2044	44mm
* R.7572-2046	46mm
* R.7572-2048	48mm
R.7572-2050	50mm
* R.7572-2052	52mm
* R.7572-2054	54mm
R.7572-2056	56mm
* R.7572-2058	58mm
* R.7572-2060	60mm
R.7572-2062	62mm

* These sizes are produced optionally



Arthroplasty Systems

Total Knee Joint Prosthesis

Femoral Component P/S



REF. NO (CoCrMo Alloy)	SIZE (mm)
7513-1001	2/55-R
7513-1002	4/60-R
7513-1003	6/65-R
7513-1004	8/70-R
7513-1005	10/75-R
7513-2001	2/55-L
7513-2002	4/60-L
7513-2003	6/65-L
7513-2004	8/70-L
7513-2005	10/75-L

Femoral Component C/R



REF. NO (CoCrMo Alloy)	SIZE (mm)
7503-1001	2/55-R
7503-1002	4/60-R
7503-1003	6/65-R
7503-1004	8/70-R
7503-1005	10/75-R
7503-2001	2/55-L
7503-2002	4/60-L
7503-2003	6/65-L
7503-2004	8/70-L
7503-2005	10/75-L



Tibia Component



REF. NO (CoCrMo Alloy)	SIZE (mm)
7693-0001	2/55
7693-0002	4/60
7693-0003	6/65
7693-0004	8/70
7693-0005	10/75

Plate Systems & Screws

- Large Fragment Locking Plate System
- Large Fragment Screws
- Small Fragment Locking Plate System
- Pelvic & Acetabulum Plate System
- Small Fragment Screw
- Cannulated Screws
- Headless Cannulated Screws
- Locking Mini Plate System
- Locking DHS-DCS Plate System

Arthroplasty Systems

- Hip Joint Prosthesis
- Revision Hip Joint Prosthesis
- Total Knee Joint Prosthesis**
- Vision-R Knee

Nail System

- PFNA Nail System
- ZFN Multi-Purpose Femoral Nail Systems
- Femur-Tibia Arthrodesis Nail Systems
- Retrograde Femoral Nail
- ZTN Tibial Nail Systems
- Cannulated Intramedullary Humeral Nail
- Titanium Elastic Nail

External Fixation System

- External Fixator
- External Hybrid Fixator
- Small External Tubular Fixator
- Large External Tubular Fixator

- Skeletal Pin and Wires
- Spinal System
- Arthroscopy

Arthroplasty Systems

Total Knee Joint Prosthesis



Plate Systems & Screws

- Large Fragment Locking Plate System
- Large Fragment Screws
- Small Fragment Locking Plate System
- Pelvic & Acetabulum Plate System
- Small Fragment Screw
- Cannulated Screws
- Headless Cannulated Screws
- Locking Mini Plate System
- Locking DHS-DCS Plate System

Arthroplasty Systems

- Hip Joint Prosthesis
- Revision Hip Joint Prosthesis
- Total Knee Joint Prosthesis**
- Vision-R Knee

Nail System

- PFNA Nail System
- ZFN Multi-Purpose Femoral Nail Systems
- Femur-Tibia Arthrodesis Nail Systems
- Retrograde Femoral Nail
- ZTN Tibial Nail Systems
- Cannulated Intramedullary Humeral Nail
- Titanium Elastic Nail

External Fixation System

- External Fixator
- External Hybrid Fixator
- Small External Tubular Fixator
- Large External Tubular Fixator

- Skeletal Pin and Wires
- Spinal System
- Arthroscopy

Tibia Insert (Hyperflex) P/S



REF. NO (HYPERFLEX) (UHMWPE) (FIXED)	SIZE (mm)
7539-0101	2/9
7539-0102	2/11
7539-0103	2/13
7539-0104	2/15
7539-0105	2/17
7539-0201	4/9
7539-0202	4/11
7539-0203	4/13
7539-0204	4/15
7539-0205	4/17
7539-0301	6/9
7539-0302	6/11
7539-0303	6/13
7539-0304	6/15
7539-0305	6/17
7539-0401	8/9
7539-0402	8/11
7539-0403	8/13
7539-0404	8/15
7539-0405	8/17
7539-0501	10/9
7539-0502	10/11
7539-0503	10/13
7539-0504	10/15
7539-0505	10/17

Tibia Insert (Hyperflex) C/R



REF. NO (HYPERFLEX) (UHMWPE) (FIXED)	SIZE (mm)
7549-0101	2/9
7549-0102	2/11
7549-0103	2/13
7549-0104	2/15
7549-0105	2/17
7549-0201	4/9
7549-0202	4/11
7549-0203	4/13
7549-0204	4/15
7549-0205	4/17
7549-0301	6/9
7549-0302	6/11
7549-0303	6/13
7549-0304	6/15
7549-0305	6/17
7549-0401	8/9
7549-0402	8/11
7549-0403	8/13
7549-0404	8/15
7549-0405	8/17
7549-0501	10/9
7549-0502	10/11
7549-0503	10/13
7549-0504	10/15
7549-0505	10/17

Patella Component



REF. NO (UHMWPE)	SIZE (mm)
7849-0002	26
7849-0003	29
7849-0004	32
7849-0005	35



VISION-R KNEE

Arthroplasty Systems

Vision-R Knee

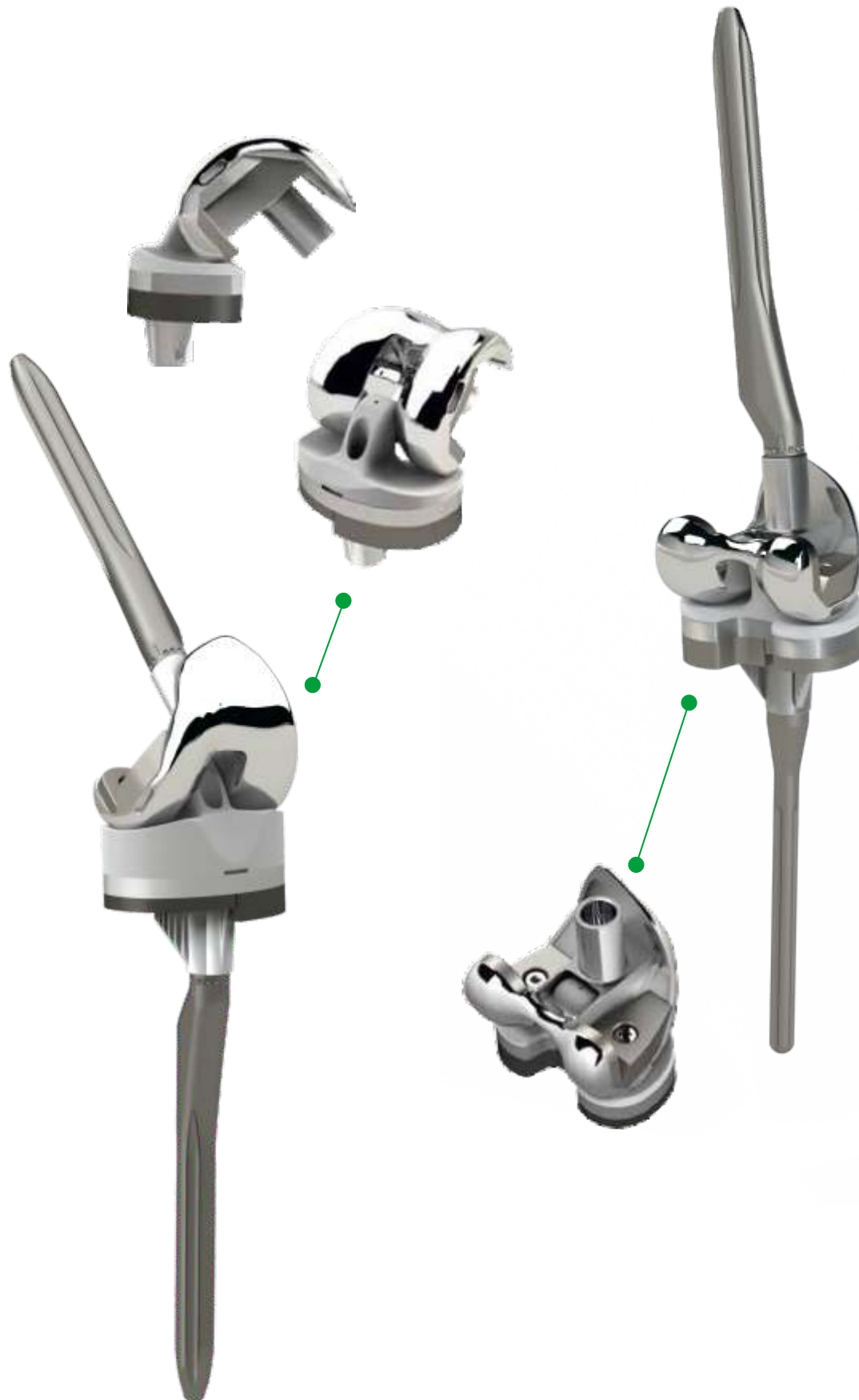



Arthroplasty Systems

Vision-R Knee

Plate Systems & Screws

- Large Fragment Locking Plate System
- Large Fragment Screws
- Small Fragment Locking Plate System
- Pelvic & Acetabulum Plate System
- Small Fragment Screw
- Cannulated Screws
- Headless Cannulated Screws
- Locking Mini Plate System
- Locking DHS-DCS Plate System

Arthroplasty Systems

- Hip Joint Prosthesis
- Revision Hip Joint Prosthesis
- Total Knee Joint Prosthesis
- Vision-R Knee**

Nail System

- PFNA Nail System
- ZFN Multi-Purpose Femoral Nail Systems
- Femur-Tibia Arthrodesis Nail Systems
- Retrograde Femoral Nail
- ZTN Tibial Nail Systems
- Cannulated Intramedullary Humeral Nail
- Titanium Elastic Nail

External Fixation System

- External Fixator
- External Hybrid Fixator
- Small External Tubular Fixator
- Large External Tubular Fixator

- Skeletal Pin and Wires
- Spinal System
- Arthroscopy

Revision Knee Prosthesis Straight Stem

REF. NO	HOLES
R.7042-0906	9-60
R.7042-0910	9-100
R.7042-0913	9-130
R.7042-1006	10-60
R.7042-1010	10-100
R.7042-1013	10-130
R.7042-1106	11-60
R.7042-1110	11-100
R.7042-1113	11-130
R.7042-1206	12-60
R.7042-1210	12-100
R.7042-1213	12-130
R.7042-1306	13-60
R.7042-1310	13-100
R.7042-1313	13-130
R.7042-1406	14-60
R.7042-1410	14-100
R.7042-1413	14-130
R.7042-1506	15-60
R.7042-1510	15-100
R.7042-1513	15-130
R.7042-1606	16-60
R.7042-1610	16-100
R.7042-1613	16-130



Revision Knee Prosthesis Offset Stem

REF. NO	HOLES
R.7052-0906	9-60
R.7052-0910	9-100
R.7052-0913	9-130
R.7052-1006	10-60
R.7052-1010	10-100
R.7052-1013	10-130
R.7052-1106	11-60
R.7052-1110	11-100
R.7052-1113	11-130
R.7052-1206	12-60
R.7052-1210	12-100
R.7052-1213	12-130
R.7052-1306	13-60
R.7052-1310	13-100
R.7052-1313	13-130
R.7052-1406	14-60
R.7052-1410	14-100
R.7052-1413	14-130
R.7052-1506	15-60
R.7052-1510	15-100
R.7052-1513	15-130
R.7052-1606	16-60
R.7052-1610	16-100
R.7052-1613	16-130



Arthroplasty Systems

Vision-R Knee



Plate Systems & Screws

- Large Fragment Locking Plate System
- Large Fragment Screws
- Small Fragment Locking Plate System
- Pelvic & Acetabulum Plate System
- Small Fragment Screw
- Cannulated Screws
- Headless Cannulated Screws
- Locking Mini Plate System
- Locking DHS-DCS Plate System

Arthroplasty Systems

- Hip Joint Prosthesis
- Revision Hip Joint Prosthesis
- Total Knee Joint Prosthesis
- Vision-R Knee**

Nail System

- PFNA Nail System
- ZFN Multi-Purpose Femoral Nail Systems
- Femur-Tibia Arthrodesis Nail Systems
- Retrograde Femoral Nail
- ZTN Tibial Nail Systems
- Cannulated Intramedullary Humeral Nail
- Titanium Elastic Nail

External Fixation System

- External Fixator
- External Hybrid Fixator
- Small External Tubular Fixator
- Large External Tubular Fixator

- Skeletal Pin and Wires
- Spinal System
- Arthroscopy

Revision Knee Prosthesis Tibia Plato



REF. NO	SIZE
R.7013-0002	2 - (A)
R.7013-0003	3 - (A)
R.7013-0004	4 - (B)
R.7013-0005	5 - (B)
R.7013-0006	6 - (C)
R.7013-0007	7 - (C)

Revision Knee Prosthesis Femoral Component



REF. NO (CoCrMo Alloy)	SIZE
R.7023-1002	2-R (A)
R.7023-1003	3-R (A)
R.7023-1004	4-R (B)
R.7023-1005	5-R (B)
R.7023-1006	6-R (C)
R.7023-1007	7-R (C)
R.7023-2002	2-L (A)
R.7023-2003	3-L (A)
R.7023-2004	4-L (B)
R.7023-2005	5-L (B)
R.7023-2006	6-L (C)
R.7023-2007	7-L (C)

Revision Knee Prosthesis Tibia Insert



REF. NO (HYPERFLEX) (UHMWPE) (FIXED)	HOLES
R.7039-0009	A-9
R.7039-0011	A-11
R.7039-0013	A-13
R.7039-0015	A-15
R.7039-0017	A-17
R.7039-0019	A-19
R.7039-0021	A-21
R.7039-1009	B-9
R.7039-1011	B-11
R.7039-1013	B-13
R.7039-1015	B-15
R.7039-1017	B-17
R.7039-1019	B-19
R.7039-1021	B-21
R.7039-2009	C-9
R.7039-2011	C-11
R.7039-2013	C-13
R.7039-2015	C-15
R.7039-2017	C-17
R.7039-2019	C-19
R.7039-2021	C-21

Revision Knee Prosthesis Insert Screw



REF. NO	SIZE (mm)
R.7122-0533	5x33

Arthroplasty Systems

Vision-R Knee



Plate Systems & Screws

- Large Fragment Locking Plate System
- Large Fragment Screws
- Small Fragment Locking Plate System
- Pelvic & Acetabulum Plate System
- Small Fragment Screw
- Cannulated Screws
- Headless Cannulated Screws
- Locking Mini Plate System
- Locking DHS-DCS Plate System

Arthroplasty Systems

- Hip Joint Prosthesis
- Revision Hip Joint Prosthesis
- Total Knee Joint Prosthesis
- Vision-R Knee**

Nail System

- PFNA Nail System
- ZFN Multi-Purpose Femoral Nail Systems
- Femur-Tibia Arthrodesis Nail Systems
- Retrograde Femoral Nail
- ZTN Tibial Nail Systems
- Cannulated Intramedullary Humeral Nail
- Titanium Elastic Nail

External Fixation System

- External Fixator
- External Hybrid Fixator
- Small External Tubular Fixator
- Large External Tubular Fixator

- Skeletal Pin and Wires
- Spinal System
- Arthroscopy

Revision Knee Prosthesis Tibia Plato Half Wedge



REF. NO	HOLES
R.7082-0502	5 / 2
R.7082-1002	10 / 2
R.7082-0503	5 / 3
R.7082-1003	10 / 3
R.7082-0504	5 / 4
R.7082-1004	10 / 4
R.7082-0505	5 / 5
R.7082-1005	10 / 5
R.7082-0506	5 / 6
R.7082-1006	10 / 6
R.7082-0507	5 / 7
R.7082-1007	10 / 7

Revision Knee Prosthesis Femur Posterior Wedge



REF. NO	SIZE
R.7072-0502	5 / 2
R.7072-1002	10 / 2
R.7072-0503	5 / 3
R.7072-1003	10 / 3
R.7072-0504	5 / 4
R.7072-1004	10 / 4
R.7072-0505	5 / 5
R.7072-1005	10 / 5
R.7072-0506	5 / 6
R.7072-1006	10 / 6
R.7072-0507	5 / 7
R.7072-1007	10 / 7

Revision Knee Prosthesis Femur Distal Wedge



REF. NO	SIZE
R.7062-0502	5 / 2
R.7062-1002	10 / 2
R.7062-0503	5 / 3
R.7062-1003	10 / 3
R.7062-0504	5 / 4
R.7062-1004	10 / 4
R.7062-0505	5 / 5
R.7062-1005	10 / 5
R.7062-0506	5 / 6
R.7062-1006	10 / 6
R.7062-0507	5 / 7
R.7062-1007	10 / 7

Revision Knee Prosthesis Tibia Wedge Screw



REF. NO	SIZE (mm)
R.7122-0505	5x5
R.7122-0506	5x6



NAILS





Plate Systems



Arthroplasty Systems



Nail Systems⁺

PFNA Nail Systems	47
ZFN Multi-Purpose Femoral Nail Systems	49
Femur-Tibia Arthrodesis Nail Systems	50
Retrograde Femoral Nail	51
ZTN Tibial Nail Systems	52
Cannulated Intramedullary Humeral Nail	53
Titanium Elastic Nail	54



External Fixation Systems

Skeletal Pins and Wires

Spinal Systems

Arthroscopy

SYSTEMS



Intramedullary Nails

PFNA Nail Systems

Plate Systems & Screws

- Large Fragment Locking Plate System
- Large Fragment Screws
- Small Fragment Locking Plate System
- Pelvic & Acetabulum Plate System
- Small Fragment Screw
- Cannulated Screws
- Headless Cannulated Screws
- Locking Mini Plate System
- Locking DHS-DCS Plate System

Arthroplasty Systems

- Hip Joint Prosthesis
- Revision Hip Joint Prosthesis
- Total Knee Joint Prosthesis
- Vision-R Knee

Nail System

- PFNA Nail System**
- ZFN Multi-Purpose Femoral Nail Systems
- Femur-Tibia Arthrodesis Nail Systems
- Retrograde Femoral Nail
- ZTN Tibial Nail Systems
- Cannulated Intramedullary Humeral Nail
- Titanium Elastic Nail

External Fixation System

- External Fixator
- External Hybrid Fixator
- Small External Tubular Fixator
- Large External Tubular Fixator

- Skeletal Pin and Wires
- Spinal System
- Arthroscopy



Simplelock / Interclaw Proximal Femoral Nail Anti-Rotation

SHORT		LONG		RIGHT		LONG		LEFT	
REF. NO	LENGTH (mm)	REF. NO	LENGTH (mm)	REF. NO	LENGTH (mm)	REF. NO	LENGTH (mm)	REF. NO	LENGTH (mm)
4552-1017	10x170	4752-1034	10x340	4762-1034	10x340				
4552-1020	10x200	4752-1036	10x360	4762-1036	10x360				
4552-1024	10x240	4752-1038	10x380	4762-1038	10x380				
4552-1117	11x170	4752-1134	11x340	4762-1134	11x340				
4552-1120	11x200	4752-1136	11x360	4762-1136	11x360				
4552-1124	11x240	4752-1138	11x380	4762-1138	11x380				
4552-1217	12x170	4752-1234	12x340	4762-1234	12x340				
4552-1220	12x200	4752-1236	12x360	4762-1236	12x360				
4552-1224	12x240	4752-1238	12x380	4762-1238	12x380				
4552-1317	13x170	4752-1334	13x340	4762-1334	13x340				
4552-1320	13x200	4752-1336	13x360	4762-1336	13x360				
4552-1324	13x240	4752-1338	13x380	4762-1338	13x380				
4552-1417	14x170								
4552-1420	14x200								
4552-1424	14x240								

Lag Screw

REF. NO	LENGTH (mm)
4582-0080	80
4582-0085	85
4582-0090	90
4582-0095	95
4582-0100	100
4582-0105	105
4582-0110	110
4582-0115	115
4582-0120	120



PFNA (Gamma) Distal Locking Screw (Ø 4.8 mm)

REF. NO	LENGTH (mm)
4992-4830	30
4992-4835	35
4992-4840	40
4992-4845	45
4992-4850	50
4992-4855	55
4992-4860	60
4992-4865	65
4992-4870	70
4992-4875	75
4992-4880	80
4992-4885	85
4992-4890	90



PFNA End Cap

REF. NO	LENGTH (mm)
4562-0000	0
4562-0005	5
4562-0010	10



Intramedullary Nails

PFNA Nail Systems



Plate Systems & Screws

- Large Fragment Locking Plate System
- Large Fragment Screws
- Small Fragment Locking Plate System
- Pelvic & Acetabulum Plate System
- Small Fragment Screw
- Cannulated Screws
- Headless Cannulated Screws
- Locking Mini Plate System
- Locking DHS-DCS Plate System

Arthroplasty Systems

- Hip Joint Prosthesis
- Revision Hip Joint Prosthesis
- Total Knee Joint Prosthesis
- Vision-R Knee

Nail System

- PFNA Nail System
- ZFN Multi-Purpose Femoral Nail Systems
- Femur-Tibia Arthrodesis Nail Systems
- Retrograde Femoral Nail
- ZTN Tibial Nail Systems
- Cannulated Intramedullary Humeral Nail
- Titanium Elastic Nail

External Fixation System

- External Fixator
- External Hybrid Fixator
- Small External Tubular Fixator
- Large External Tubular Fixator

- Skeletal Pin and Wires
- Spinal System
- Arthroscopy

Simplelock Entegre Lag Screw

REF. NO	LENGTH (mm)
4782-0065	65
4782-0070	70
4782-0075	75
4782-0080	80
4782-0085	85
4782-0090	90
4782-0095	95
4782-0100	100
4782-0105	105
4782-0110	110
4782-0115	115
4782-0120	120



Simplelock Entegre Anti-Rotation Compression Screw

REF. NO	LENGTH (mm)
4792-0060	60
4792-0065	65
4792-0070	70
4792-0075	75
4792-0080	80
4792-0085	85
4792-0090	90
4792-0095	95
4792-0100	100
4792-0105	105
4792-0110	110
4792-0115	115



Interclaw LAG Screw

REF. NO	LENGTH (mm)
4642-0080	80
4642-0085	85
4642-0090	90
4642-0095	95
4642-0100	100
4642-0105	105
4642-0110	110
4642-0115	115
4642-0120	120



Interclaw LAG Blade

REF. NO	LENGTH (mm)
4592-0080	80
4592-0085	85
4592-0090	90
4592-0095	95
4592-0100	100
4592-0105	105
4592-0110	110
4592-0115	115
4592-0120	120



Interclaw End Cap



REF. NO	LENGTH (mm)
4072-0000	50
4072-0001	55

LAG Locking Screw



REF. NO (CoCrMo Alloy)
4573-0000





Intramedullary Nails

ZFN Multi-Purpose Femoral Nail Systems

ZFN Multi-Purpose Femoral Nail Systems

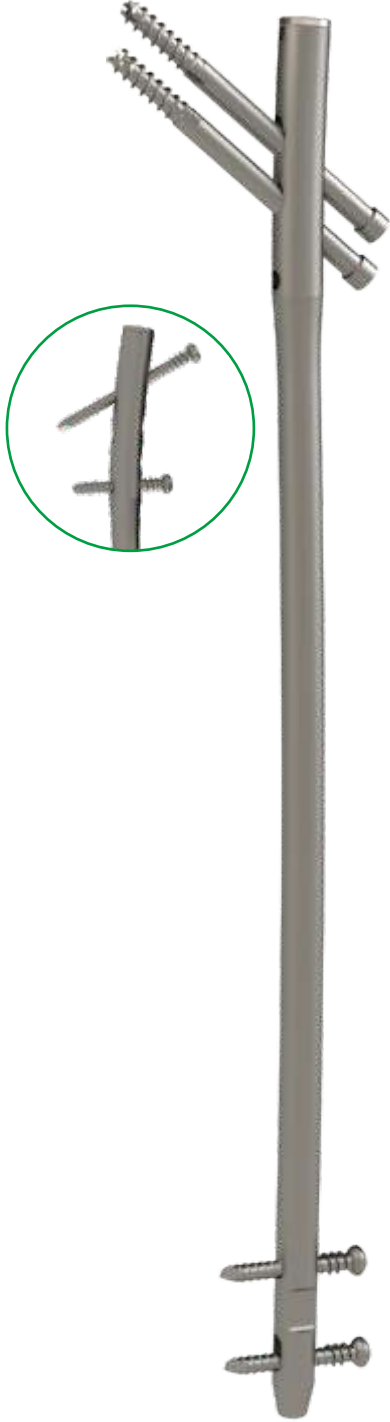

SHORT		LONG		RIGHT		LONG		LEFT	
REF. NO	SIZE (mm)	REF. NO	SIZE (mm)	REF. NO	SIZE (mm)	REF. NO	SIZE (mm)	REF. NO	SIZE (mm)
4602-0918	9x180	4262-0932	9x320			4272-0932	9x320		
4602-0920	9x200	4262-0934	9x340			4272-0934	9x340		
4602-0922	9x220	4262-0936	9x360			4272-0936	9x360		
4602-0924	9x240	4262-0938	9x380			4272-0938	9x380		
4602-1018	10x180	4262-0940	9x400			4272-0940	9x400		
4602-1020	10x200	4262-0942	9x420			4272-0942	9x420		
4602-1022	10x220	4262-0944	9x440			4272-0944	9x440		
4602-1024	10x240	4262-1032	10x 320			4272-1032	10x 320		
4602-1118	11x180	4262-1034	10x 340			4272-1034	10x 340		
4602-1120	11x200	4262-1036	10x 360			4272-1036	10x 360		
4602-1122	11x220	4262-1038	10x 380			4272-1038	10x 380		
4602-1124	11x240	4262-1040	10x 400			4272-1040	10x 400		
4602-1218	12x180	4262-1042	10x 420			4272-1042	10x 420		
4602-1220	12x200	4262-1044	10x 440			4272-1044	10x 440		
4602-1222	12x220	4262-1132	11x 320			4272-1132	11x 320		
4602-1224	12x240	4262-1134	11x 340			4272-1134	11x 340		
4602-1318	13x180	4262-1136	11x 360			4272-1136	11x 360		
4602-1320	13x200	4262-1138	11x 380			4272-1138	11x 380		
4602-1322	13x220	4262-1140	11x 400			4272-1140	11x 400		
4602-1324	13x240	4262-1142	11x 420			4272-1142	11x 420		
4602-1418	14x180	4262-1144	11x 440			4272-1144	11x 440		
4602-1420	14x200	4262-1232	12x 320			4272-1232	12x 320		
4602-1422	14x220	4262-1234	12x 340			4272-1234	12x 340		
4602-1424	14x240	4262-1236	12x 360			4272-1236	12x 360		
		4262-1238	12x 380			4272-1238	12x 380		
		4262-1240	12x 400			4272-1240	12x 400		
		4262-1242	12x 420			4272-1242	12x 420		
		4262-1244	12x 440			4272-1244	12x 440		
		4262-1332	13x 320			4272-1332	13x 320		
		4262-1334	13x 340			4272-1334	13x 340		
		4262-1336	13x 360			4272-1336	13x 360		
		4262-1338	13x 380			4272-1338	13x 380		
		4262-1340	13x 400			4272-1340	13x 400		
		4262-1342	13x 420			4272-1342	13x 420		
		4262-1344	13x 440			4272-1344	13x 440		
		4262-1432	14x 320			4272-1432	14x 320		
		4262-1434	14x 340			4272-1434	14x 340		
		4262-1436	14x 360			4272-1436	14x 360		
		4262-1438	14x 380			4272-1438	14x 380		
		4262-1440	14x 400			4272-1440	14x 400		
		4262-1442	14x 420			4272-1442	14x 420		
		4262-1444	14x 440			4272-1444	14x 440		

Plate Systems & Screws

- Large Fragment Locking Plate System
- Large Fragment Screws
- Small Fragment Locking Plate System
- Pelvic & Acetabulum Plate System
- Small Fragment Screw
- Cannulated Screws
- Headless Cannulated Screws
- Locking Mini Plate System
- Locking DHS-DCS Plate System

Arthroplasty Systems

- Hip Joint Prosthesis
- Revision Hip Joint Prosthesis
- Total Knee Joint Prosthesis
- Vision-R Knee

Nail System

- PFNA Nail System
- ZFN Multi-Purpose Femoral Nail Systems**
- Femur-Tibia Arthrodesis Nail Systems
- Retrograde Femoral Nail
- ZTN Tibial Nail Systems
- Cannulated Intramedullary Humeral Nail
- Titanium Elastic Nail

External Fixation System

- External Fixator
- External Hybrid Fixator
- Small External Tubular Fixator
- Large External Tubular Fixator

- Skeletal Pin and Wires
- Spinal System
- Arthroscopy

Intramedullary Nails

Femur-Tibia Arthrodesis Nail Systems



Plate Systems & Screws

- Large Fragment Locking Plate System
- Large Fragment Screws
- Small Fragment Locking Plate System
- Pelvic & Acetabulum Plate System
- Small Fragment Screw
- Cannulated Screws
- Headless Cannulated Screws
- Locking Mini Plate System
- Locking DHS-DCS Plate System

Arthroplasty Systems

- Hip Joint Prosthesis
- Revision Hip Joint Prosthesis
- Total Knee Joint Prosthesis
- Vision-R Knee

Nail System

- PFNA Nail System
- ZFN Multi-Purpose Femoral Nail Systems
- Femur-Tibia Arthrodesis Nail Systems**
- Retrograde Femoral Nail
- ZTN Tibial Nail Systems
- Cannulated Intramedullary Humeral Nail
- Titanium Elastic Nail

External Fixation System

- External Fixator
- External Hybrid Fixator
- Small External Tubular Fixator
- Large External Tubular Fixator

- Skeletal Pin and Wires
- Spinal System
- Arthroscopy

Proximal/Distal Locking Screw For ZFN (Ø 4.8 mm)



REF. NO	LENGTH (mm)
4292-4830	30
4292-4835	35
4292-4840	40
4292-4845	45
4292-4850	50
4292-4855	55
4292-4860	60
4292-4865	65
4292-4870	70
4292-4875	75
4292-4880	80
4292-4885	85
4292-4890	90

Femoral Lag Screw For ZFN (Ø 6.4 mm)



REF. NO	LENGTH (mm)
4612-6050	50
4612-6055	55
4612-6060	60
4612-6065	65
4612-6070	70
4612-6075	75
4612-6080	80
4612-6085	85
4612-6090	90
4612-6095	95
4612-6100	100
4612-6105	105
4612-6110	110
4612-6115	115
4612-6120	120

Proximal Lag Fixing Screw For ZFN



REF. NO
4622-0000

ZFN End Cap



REF. NO	LENGTH (mm)
4602-0000	0
4602-0005	5
4602-0010	10

Femur-Tibia Arthrodesis Nail (Custom Made)



REF. NO
4052-0000



Intramedullary Nails

Cannulated Intramedullary Retrograde Femoral Nail

Plate Systems & Screws

- Large Fragment Locking Plate System
- Large Fragment Screws
- Small Fragment Locking Plate System
- Pelvic & Acetabulum Plate System
- Small Fragment Screw
- Cannulated Screws
- Headless Cannulated Screws
- Locking Mini Plate System
- Locking DHS-DCS Plate System

Arthroplasty Systems

- Hip Joint Prosthesis
- Revision Hip Joint Prosthesis
- Total Knee Joint Prosthesis
- Vision-R Knee

Nail System

- PFNA Nail System
- ZFN Multi-Purpose Femoral Nail Systems
- Femur-Tibia Arthrodesis Nail Systems
- Retrograde Femoral Nail**
- ZTN Tibial Nail Systems
- Cannulated Intramedullary Humeral Nail
- Titanium Elastic Nail

External Fixation System

- External Fixator
- External Hybrid Fixator
- Small External Tubular Fixator
- Large External Tubular Fixator

- Skeletal Pin and Wires
- Spinal System
- Arthroscopy

REF. NO	SIZE
4122-0918	9x180
4122-0920	9x200
4122-0922	9x220
4122-0924	9x240
4122-0926	9x260
4122-0928	9x280
4122-0930	9x300
4122-0932	9x320
4122-0934	9x340
4122-0936	9x360
4122-1018	10x180
4122-1020	10x200
4122-1022	10x220
4122-1024	10x240
4122-1026	10x260
4122-1028	10x280
4122-1030	10x300
4122-1032	10x320
4122-1034	10x340
4122-1036	10x360
4122-1118	11x180
4122-1120	11x200
4122-1122	11x220
4122-1124	11x240
4122-1126	11x260
4122-1128	11x280
4122-1130	11x300
4122-1132	11x320
4122-1134	11x340
4122-1136	11x360
4122-1218	12x180
4122-1220	12x200
4122-1222	12x220
4122-1224	12x240
4122-1226	12x260
4122-1228	12x280
4122-1230	12x300
4122-1232	12x320
4122-1234	12x340
4122-1236	12x360
4122-1318	13x180
4122-1320	13x200
4122-1322	13x220
4122-1324	13x240
4122-1326	13x260
4122-1328	13x280
4122-1330	13x300
4122-1332	13x320

Cannulated Intramedullary Retrograde Femoral Nail



Proximal Locking Screw (Ø 4.8 mm)

REF. NO	LENGTH (mm)
4282-4830	30
4282-4835	35
4282-4840	40
4282-4845	45
4282-4850	50
4282-4855	55
4282-4860	60
4282-4865	65
4282-4870	70
4282-4875	75
4282-4880	80
4282-4885	85
4282-4890	90



Distal Locking Screw (Ø 4.35 mm)

REF. NO	LENGTH (mm)
4282-4330	30
4282-4335	35
4282-4340	40
4282-4345	45
4282-4350	50
4282-4355	55
4282-4360	60
4282-4365	65
4282-4370	70
4282-4375	75
4282-4380	80
4282-4385	85
4282-4390	90



Retrograde Femoral Nail End Cap



REF. NO	LENGTH (mm)
4122-0000	0
4122-0005	5
4122-0010	10

Intramedullary Nails

ZTN Tibial Nail Systems



Plate Systems & Screws

- Large Fragment Locking Plate System
- Large Fragment Screws
- Small Fragment Locking Plate System
- Pelvic & Acetabulum Plate System
- Small Fragment Screw
- Canulated Screws
- Headless Canulated Screws
- Locking Mini Plate System
- Locking DHS-DCS Plate System

Arthroplasty Systems

- Hip Joint Prosthesis
- Revision Hip Joint Prosthesis
- Total Knee Joint Prosthesis
- Vision-R Knee

Nail System

- PFNA Nail System
- ZFN Multi-Purpose Femoral Nail Systems
- Femur-Tibia Arthrodesis Nail Systems
- Retrograde Femoral Nail
- ZTN Tibial Nail Systems**
- Canulated Intramedullary Humeral Nail
- Titanium Elastic Nail

External Fixation System

- External Fixator
- External Hybrid Fixator
- Small External Tubular Fixator
- Large External Tubular Fixator

- Skeletal Pin and Wires
- Spinal System
- Arthroscopy



ZTN Tibial Nail Systems

REF. NO	SIZE (mm)
4252-0825	8x255
4252-0827	8x270
4252-0828	8x285
4252-0830	8x300
4252-0831	8x315
4252-0833	8x330
4252-0834	8x345
4252-0836	8x360
4252-0837	8x375
4252-0925	9x255
4252-0927	9x270
4252-0928	9x285
4252-0930	9x300
4252-0931	9x315
4252-0933	9x330
4252-0934	9x345
4252-0936	9x360
4252-0937	9x375
4252-1025	10x 255
4252-1027	10x 270
4252-1028	10x 285
4252-1030	10x 300
4252-1031	10x 315
4252-1033	10x 330
4252-1034	10x 345
4252-1036	10x 360
4252-1037	10x 375
4252-1125	11x 255
4252-1127	11x 270
4252-1128	11x 285
4252-1130	11x 300
4252-1131	11x 315
4252-1133	11x 330
4252-1134	11x 345
4252-1136	11x 360
4252-1137	11x 375

REF. NO	SIZE (mm)
4252-1225	12x 255
4252-1227	12x 270
4252-1228	12x 285
4252-1230	12x 300
4252-1231	12x 315
4252-1233	12x 330
4252-1234	12x 345
4252-1236	12x 360
4252-1237	12x 375
4252-1325	13x 255
4252-1327	13x 270
4252-1328	13x 285
4252-1330	13x 300
4252-1331	13x 315
4252-1333	13x 330
4252-1334	13x 345
4252-1336	13x 360
4252-1337	13x 375
4252-1425	14x 255
4252-1427	14x 270
4252-1428	14x 285
4252-1430	14x 300
4252-1431	14x 315
4252-1433	14x 330
4252-1434	14x 345
4252-1436	14x 360
4252-1437	14x 375

ZTN End Cap



REF. NO	LENGTH (mm)
4252-0000	0
4252-0005	5
4252-0010	10



Intramedullary Nails

Cannulated Intramedullary Humeral Nail

Plate Systems & Screws

- Large Fragment Locking Plate System
- Large Fragment Screws
- Small Fragment Locking Plate System
- Pelvic & Acetabulum Plate System
- Small Fragment Screw
- Cannulated Screws
- Headless Cannulated Screws
- Locking Mini Plate System
- Locking DHS-DCS Plate System

Arthroplasty Systems

- Hip Joint Prosthesis
- Revision Hip Joint Prosthesis
- Total Knee Joint Prosthesis
- Vision-R Knee

Nail System

- PFNA Nail System
- ZFN Multi-Purpose Femoral Nail Systems
- Femur-Tibia Arthrodesis Nail Systems
- Retrograde Femoral Nail
- ZTN Tibial Nail Systems
- Cannulated Intramedullary Humeral Nail**
- Titanium Elastic Nail

External Fixation System

- External Fixator
- External Hybrid Fixator
- Small External Tubular Fixator
- Large External Tubular Fixator

- Skeletal Pin and Wires
- Spinal System
- Arthroscopy

Cannulated Intramedullary Humeral Nail



REF. NO	SIZE (mm)
4102-0716	7x160
4102-0718	7x180
4102-0720	7x200
4102-0722	7x220
4102-0724	7x240
4102-0726	7x260
4102-0728	7x280
4102-0816	8x160
4102-0818	8x180
4102-0820	8x200
4102-0822	8x220
4102-0824	8x240
4102-0826	8x260
4102-0828	8x280
4102-0916	9x160
4102-0918	9x180
4102-0920	9x200
4102-0922	9x220
4102-0924	9x240
4102-0926	9x260
4102-0928	9x280

Locking Screws for Nails (Ø 3.5 mm)



REF. NO	LENGTH (mm)
4042-0020	20
4042-0022	22
4042-0024	24
4042-0025	25
4042-0026	26
4042-0028	28
4042-0030	30
4042-0032	32
4042-0034	34
4042-0035	35
4042-0036	36
4042-0038	38
4042-0040	40
4042-0042	42
4042-0044	44
4042-0045	45
4042-0046	46
4042-0048	48
4042-0050	50

Humeral Nail End Cap



REF. NO	LENGTH (mm)
4112-0000	0

Intramedullary Nails

Titanium Elastic Nail



Plate Systems & Screws

- Large Fragment Locking Plate System
- Large Fragment Screws
- Small Fragment Locking Plate System
- Pelvic & Acetabulum Plate System
- Small Fragment Screw
- Cannulated Screws
- Headless Cannulated Screws
- Locking Mini Plate System
- Locking DHS-DCS Plate System

Arthroplasty Systems

- Hip Joint Prosthesis
- Revision Hip Joint Prosthesis
- Total Knee Joint Prosthesis
- Vision-R Knee

Nail System

- PFNA Nail System
- ZFN Multi-Purpose Femoral Nail Systems
- Femur-Tibia Arthrodesis Nail Systems
- Retrograde Femoral Nail
- ZTN Tibial Nail Systems
- Cannulated Intramedullary Humeral Nail
- Titanium Elastic Nail**

External Fixation System

- External Fixator
- External Hybrid Fixator
- Small External Tubular Fixator
- Large External Tubular Fixator

- Skeletal Pin and Wires
- Spinal System
- Arthroscopy

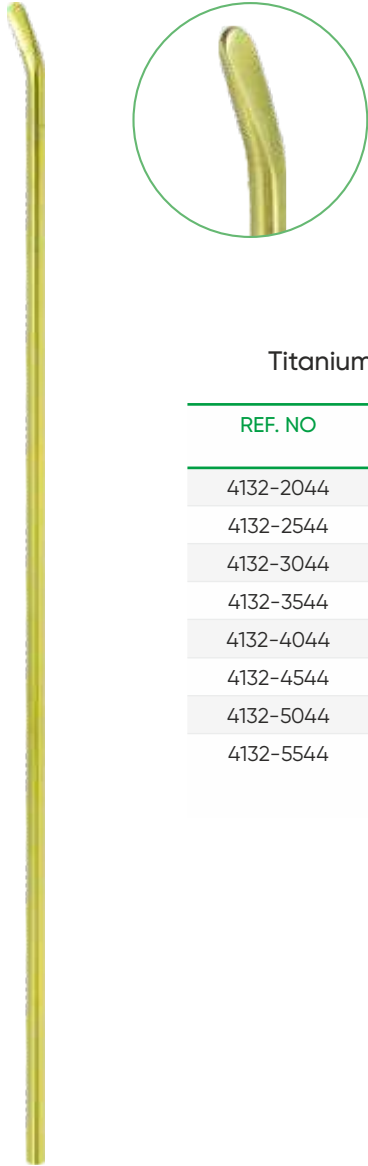

Titanium Elastic Nail

REF. NO	LENGTH (mm)
4132-2044	2.0x440
4132-2544	2.5X 440
4132-3044	3.0x440
4132-3544	3.5X440
4132-4044	4.0x440
4132-4544	4.5X440
4132-5044	5.0x440
4132-5544	5.5x440

Titanium Elastic Nail End Cap



REF. NO	LENGTH (mm)
4132-0020	2mm
4132-0025	2.5mm
4132-0030	3mm
4132-0035	3.5mm
4132-0040	4mm
4132-0045	4.5mm
4132-0050	5mm
4132-0055	5.5mm

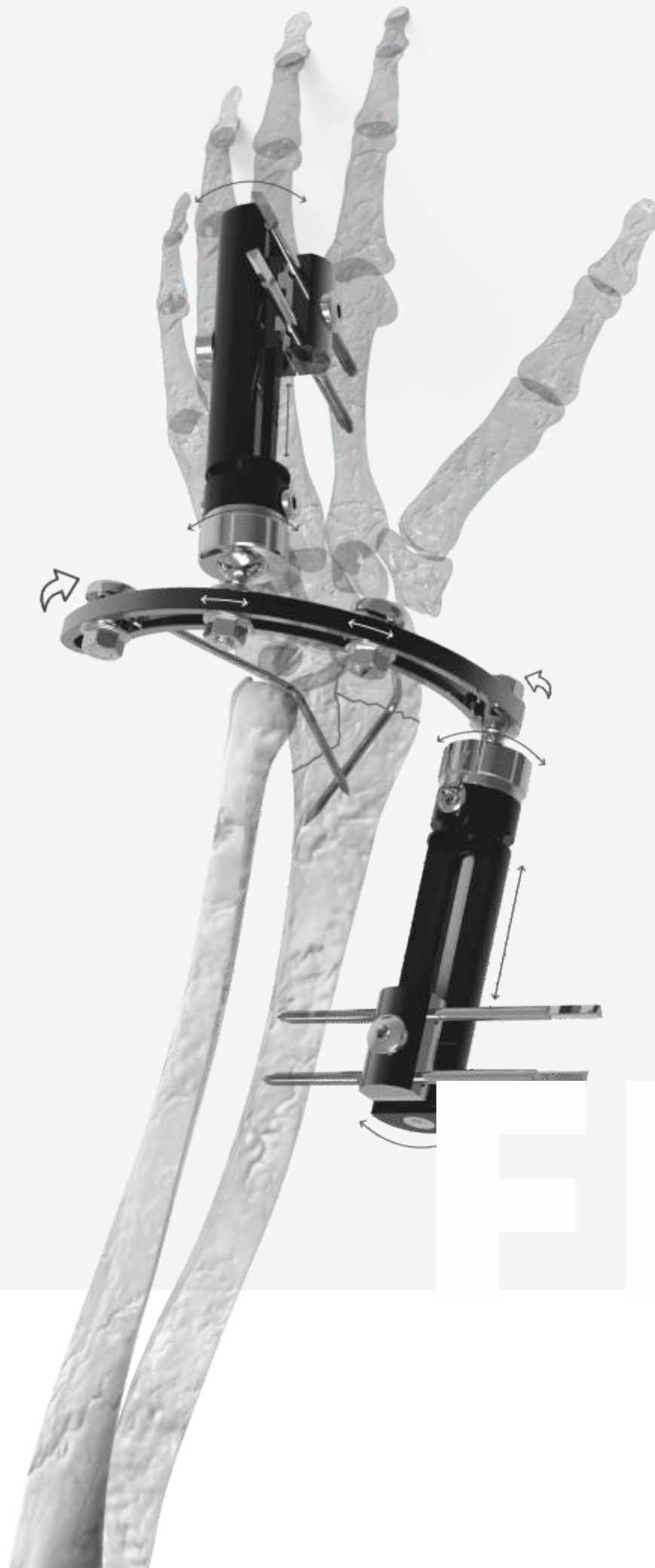



Plate Systems



Arthroplasty Systems



Nail Systems



External Fixation Systems⁺

External Fixators	57
External Hybrid Fixators	60
Small External Tubular Fixator Set	61
Large External Tubular Fixator Set	62

Skeletal Pins and Wires

Spinal Systems

Arthroscopy

KATORS



External Fixation Systems

External Fixators

Plate Systems & Screws

- Large Fragment Locking Plate System
- Large Fragment Screws
- Small Fragment Locking Plate System
- Pelvic & Acetabulum Plate System
- Small Fragment Screw
- Cannulated Screws

Headless Cannulated Screws

- Locking Mini Plate System
- Locking DHS-DCS Plate System

Arthroplasty Systems

- Hip Joint Prosthesis
- Revision Hip Joint Prosthesis
- Total Knee Joint Prosthesis
- Vision-R Knee

Nail System

- PFNA Nail System
- ZFN Multi-Purpose Femoral Nail Systems
- Femur-Tibia Arthrodesis Nail Systems
- Retrograde Femoral Nail
- ZTN Tibial Nail Systems
- Cannulated Intramedullary Humeral Nail
- Titanium Elastic Nail

External Fixation System

External Fixator

- External Hybrid Fixator
- Small External Tubular Fixator
- Large External Tubular Fixator

Skeletal Pin and Wires

Spinal System

Arthroscopy

Extremity Elbow Fixator



REF. NO
5934-0000

Segmental Humerus Fixator



REF. NO	SIZE
5164-0001	S
5164-0002	M
5164-0003	L

Dynamic Axial External Fixator (Humerus)



REF. NO	SIZE
5024-0001	S
5024-0002	M
5024-0003	L

T Clamp Humerus



REF. NO
5104-0000

Penning Type External Fixator



REF. NO	SIZE
5034-0001	S
5034-0002	M
5034-0003	L

Finger Fixator (Joint)



REF. NO
5084-0000

Dynamic Finger Fixator



REF. NO
5084-0002

Lengthener Finger Fixator



REF. NO	SIZE
5084-0010	S
5084-0020	M
5084-0030	L

External Fixation Systems

External Fixators



Dynamic Axial External Fixator (Pelvic)



REF. NO
5044-0000

Segmental Fixators



REF. NO	SIZE
5074-0001	S
5074-0002	M
5074-0003	L

Dynamic Axial External Fixator (Pelvic)



REF. NO	SIZE
5044-0001	S
5044-0002	M
5044-0003	L

Limb Lengthener Fixators



REF. NO	SIZE
5054-0001	S
5054-0002	M
5054-0003	L

Pilon Fixators



REF. NO	SIZE
5064-0001	S
5064-0002	M
5064-0003	L

Dynamic Axial External Fixator (Femur - Tibia)



REF. NO	SIZE
5014-0001	S
5014-0002	M
5014-0003	L

T Clamp Femur



REF. NO
5094-0001

135° Clamp (On)



REF. NO
5104-0001

135° Clamp (Off)



REF. NO
5104-0002

Plate Systems & Screws

- Large Fragment Locking Plate System
- Large Fragment Screws
- Small Fragment Locking Plate System
- Pelvic & Acetabulum Plate System
- Small Fragment Screw
- Cannulated Screws
- Headless Cannulated Screws
- Locking Mini Plate System
- Locking DHS-DCS Plate System

Arthroplasty Systems

- Hip Joint Prosthesis
- Revision Hip Joint Prosthesis
- Total Knee Joint Prosthesis
- Vision-R Knee

Nail System

- PFNA Nail System
- ZFN Multi-Purpose Femoral Nail Systems
- Femur-Tibia Arthrodesis Nail Systems
- Retrograde Femoral Nail
- ZTN Tibial Nail Systems
- Cannulated Intramedullary Humeral Nail
- Titanium Elastic Nail

External Fixation System

- External Fixator
- External Hybrid Fixator
- Small External Tubular Fixator
- Large External Tubular Fixator

- Skeletal Pin and Wires
- Spinal System
- Arthroscopy

External Fixation Systems

External Fixators



Plate Systems & Screws

Large Fragment Locking Plate System

Large Fragment Screws

Small Fragment Locking Plate System

Pelvic & Acetabulum Plate System

Small Fragment Screw

Cannulated Screws

Headless Cannulated Screws

Locking Mini Plate System

Locking DHS-DCS Plate System

Arthroplasty Systems

Hip Joint Prosthesis

Revision Hip Joint Prosthesis

Total Knee Joint Prosthesis

Vision-R Knee

Nail System

PFNA Nail System

ZFN Multi-Purpose Femoral Nail Systems

Femur-Tibia Arthrodesis Nail Systems

Retrograde Femoral Nail

ZTN Tibial Nail Systems

Cannulated Intramedullary Humeral Nail

Titanium Elastic Nail

External Fixation System

External Fixator

External Hybrid Fixator

Small External Tubular Fixator

Large External Tubular Fixator

Skeletal Pin and Wires

Spinal System

Arthroscopy

Hybrit Hand-Wrist Fixator (Kit)



REF. NO

5134-0000

Hand-Wrist Fixator (Kit)

REF. NO

5224-0000



Radiolucent Compression Hand-Wrist Fixator (Kit)

REF. NO

5508-0000



Mini Tubular External Fixator (Kit)

REF. NO

5884-0000



Mini Hybrit External Fixator (Kit)

REF. NO

5784-0000





External Fixation Systems

External Hybrid Fixators



Humerus Hybrid External Fixator (Kit)

REF. NO

5294-0000

Plate Systems & Screws

- Large Fragment Locking Plate System
- Large Fragment Screws
- Small Fragment Locking Plate System
- Pelvic & Acetabulum Plate System
- Small Fragment Screw
- Cannulated Screws
- Headless Cannulated Screws
- Locking Mini Plate System
- Locking DHS-DCS Plate System

Arthroplasty Systems

- Hip Joint Prosthesis
- Revision Hip Joint Prosthesis
- Total Knee Joint Prosthesis
- Vision-R Knee

Nail System

- PFNA Nail System
- ZFN Multi-Purpose Femoral Nail Systems
- Femur-Tibia Arthrodesis Nail Systems
- Retrograde Femoral Nail
- ZTN Tibial Nail Systems
- Cannulated Intramedullary Humeral Nail
- Titanium Elastic Nail

External Fixation System

- External Fixator
- External Hybrid Fixator**
- Small External Tubular Fixator
- Large External Tubular Fixator

- Skeletal Pin and Wires
- Spinal System
- Arthroscopy

Femur-Tibia Hybrid Fixator

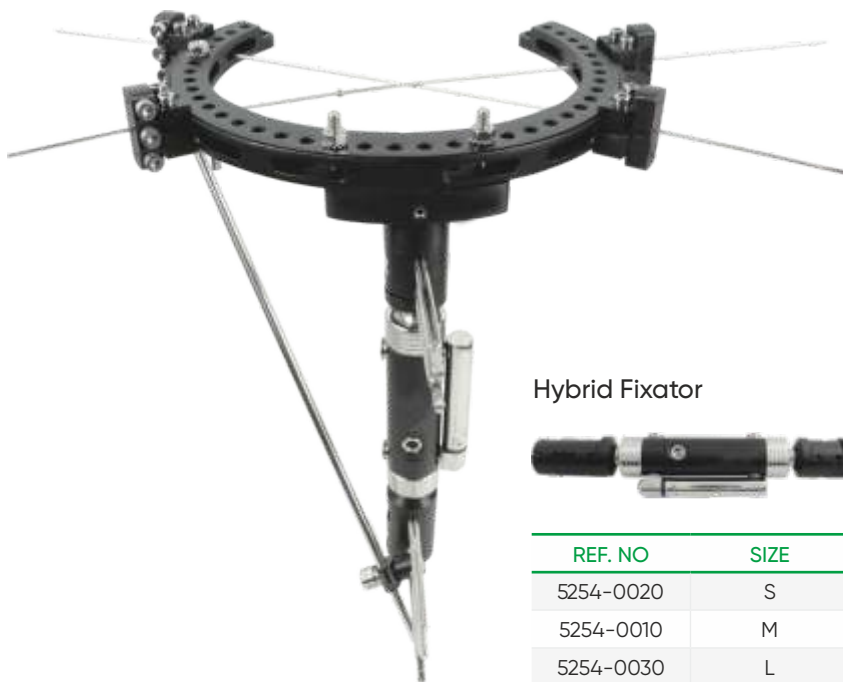

Hybrid Fixator

REF. NO	SIZE
5254-0020	S
5254-0010	M
5254-0030	L

Hybrid Fixator Rod Clamp

REF. NO

5254-0012



Hybrid Clamp

REF. NO

5254-0015



Hybrid Fixator Wire Clamp

REF. NO

5254-0013



Hybrid Fixator Rod Connection Part

REF. NO

5254-0014



Hybrid Fixator Rod 6x400 mm

REF. NO

5255-0640

Olive Kirschner Wire Ø 2x440

REF. NO

6251-2044

Kirschner Wire Ø 2x440

REF. NO

6041-2044

Hybrid Fixator Ring

REF. NO

5254-0170

5254-0190





External Fixation Systems

Small External Tubular Fixator Set

Plate Systems & Screws

- Large Fragment Locking Plate System
- Large Fragment Screws
- Small Fragment Locking Plate System
- Pelvic & Acetabulum Plate System
- Small Fragment Screw
- Cannulated Screws
- Headless Cannulated Screws
- Locking Mini Plate System
- Locking DHS-DCS Plate System

Rod-Rod Clamp Ø 5 mm

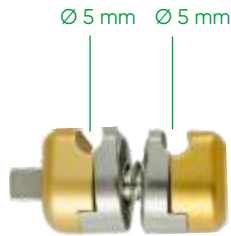

REF. NO
(AL)

5144-0020

Schanz - Rod Clamp

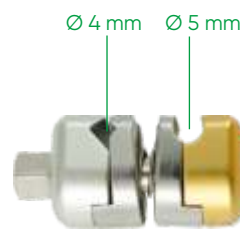

REF. NO
(AL)

5144-0023

Arthroplasty Systems

- Hip Joint Prosthesis
- Revision Hip Joint Prosthesis
- Total Knee Joint Prosthesis
- Vision-R Knee

Multiplanar Pin Clamp



REF. NO
(AL)

5144-0001

Double Planar Pin Holder Clamp



REF. NO
(AL)

5144-0005

Rod Ø 5 mm



REF. NO (TI)	REF. NO (AL)	REF. NO (CR)	LENGTH (mm)
5142-0510	5144-0510	5148-0510	100
5142-0518	5144-0518	5148-0518	180
5142-0520	5144-0520	5148-0520	200
5142-0522	5144-0522	5148-0522	220
5142-0524	5144-0524	5148-0524	240
5142-0526	5144-0526	5148-0526	260
5142-0528	5144-0528	5148-0528	280
5142-0530	5144-0530	5148-0530	300
5142-0532	5144-0532	5148-0532	320
5142-0534	5144-0534	5148-0534	340
5142-0536	5144-0536	5148-0536	360
5142-0538	5144-0538	5148-0538	380
5142-0540	5144-0540	5148-0540	400

Angled Connection Part 30°



REF. NO
(SS)

5141-0025

Horizontal Connection Part



REF. NO
(SS)

5141-0020

Angled Corner Ring

REF. NO
(AL) SIZE

5144-0003 S

5144-0004 L



Nail System

- PFNA Nail System
- ZFN Multi-Purpose Femoral Nail Systems
- Femur-Tibia Arthrodesis Nail Systems
- Retrograde Femoral Nail
- ZTN Tibial Nail Systems
- Cannulated Intramedullary Humeral Nail
- Titanium Elastic Nail

External Fixation System

- External Fixator
- External Hybrid Fixator
- Small External Tubular Fixator**
- Large External Tubular Fixator

- Skeletal Pin and Wires
- Spinal System
- Arthroscopy

External Fixation Systems

Large External Tubular Fixator Set

zimed[®]

Plate Systems & Screws

- Large Fragment Locking Plate System
- Large Fragment Screws
- Small Fragment Locking Plate System
- Pelvic & Acetabulum Plate System
- Small Fragment Screw
- Canulated Screws
- Headless Canulated Screws
- Locking Mini Plate System
- Locking DHS-DCS Plate System

Arthroplasty Systems

- Hip Joint Prosthesis
- Revision Hip Joint Prosthesis
- Total Knee Joint Prosthesis
- Vision-R Knee

Nail System

- PFNA Nail System
- ZFN Multi-Purpose Femoral Nail Systems
- Femur-Tibia Arthrodesis Nail Systems
- Retrograde Femoral Nail
- ZTN Tibial Nail Systems
- Canulated Intramedullary Humeral Nail
- Titanium Elastic Nail

External Fixation System

- External Fixator
- External Hybrid Fixator
- Small External Tubular Fixator
- Large External Tubular Fixator**

- Skeletal Pin and Wires
- Spinal System
- Arthroscopy

Rod-Rod Clamp Ø 8 mm

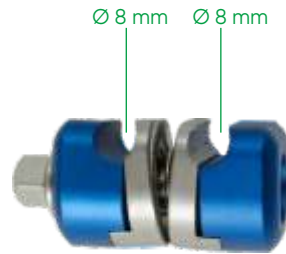

REF. NO
(AL)

5144-0021

Schanz - Rod Clamp

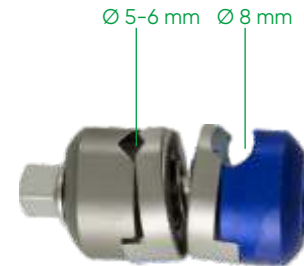

REF. NO
(AL)

5144-0024

Rod Ø 8 mm



REF. NO (TI)	REF. NO (AL)	REF. NO (CR)	LENGTH (mm)
5142-0818	5144-0818	5148-0818	180
5142-0820	5144-0820	5148-0820	200
5142-0822	5144-0822	5148-0822	220
5142-0824	5144-0824	5148-0824	240
5142-0826	5144-0826	5148-0826	260
5142-0828	5144-0828	5148-0828	280
5142-0830	5144-0830	5148-0830	300
5142-0832	5144-0832	5148-0832	320
5142-0834	5144-0834	5148-0834	340
5142-0836	5144-0836	5148-0836	360
5142-0838	5144-0838	5148-0838	380
5142-0840	5144-0840	5148-0840	400

Double Planar Pin Holder Clamp



REF. NO
(AL)

5144-0006

Angled Connection Part 30°



REF. NO
(SS)

5141-0015

Angled Corner Ring



REF. NO (AL)	LEN-GTH (mm)
5144-0140	140
5144-0156	156
5144-0192	192

Horizontal Connection Part



REF. NO
(SS)

5141-0010
5141-0015
5141-0020
5141-0025



Skeletal Pins and Wires

Plate Systems & Screws

- Large Fragment Locking Plate System
- Large Fragment Screws
- Small Fragment Locking Plate System
- Pelvic & Acetabulum Plate System
- Small Fragment Screw
- Cannulated Screws
- Headless Cannulated Screws
- Locking Mini Plate System
- Locking DHS-DCS Plate System

Arthroplasty Systems

- Hip Joint Prosthesis
- Revision Hip Joint Prosthesis
- Total Knee Joint Prosthesis
- Vision-R Knee

Nail System

- PFNA Nail System
- ZFN Multi-Purpose Femoral Nail Systems
- Femur-Tibia Arthrodesis Nail Systems
- Retrograde Femoral Nail
- ZTN Tibial Nail Systems
- Cannulated Intramedullary Humeral Nail
- Titanium Elastic Nail

External Fixation System

- External Fixator
- External Hybrid Fixator
- Small External Tubular Fixator
- Large External Tubular Fixator

Skeletal Pin and Wires

- Spinal System
- Arthroscopy

Schanz Screw (Cortical Threaded)



REF. NO (SS)	LENGTH (mm)	DIAMETER
6011-2050	50	Ø 2mm
6011-2060	60	Ø 2mm
6011-2070	70	Ø 2mm
6011-2080	80	Ø 2mm
6011-2090	90	Ø 2mm
6011-2100	100	Ø 2mm
6011-3060	60	Ø 3mm
6011-3070	70	Ø 3mm
6011-3080	80	Ø 3mm
6011-3090	90	Ø 3mm
6011-3100	100	Ø 3mm
6011-3110	110	Ø 3mm
6011-3120	120	Ø 3mm
6011-4070	70	Ø 4mm
6011-4080	80	Ø 4mm
6011-4090	90	Ø 4mm
6011-4100	100	Ø 4mm
6011-4110	110	Ø 4mm
6011-4120	120	Ø 4mm
6011-4130	130	Ø 4mm
6011-4140	140	Ø 4mm

REF. NO (SS)	LENGTH (mm)	DIAMETER
6011-5140	140	Ø 5mm
6011-5160	160	Ø 5mm
6011-5180	180	Ø 5mm
6011-5200	200	Ø 5mm
6011-5220	220	Ø 5mm
6011-5240	240	Ø 5mm
6011-5260	260	Ø 5mm
6011-6140	140	Ø 6mm
6011-6160	160	Ø 6mm
6011-6180	180	Ø 6mm
6011-6200	200	Ø 6mm
6011-6220	220	Ø 6mm
6011-6240	240	Ø 6mm
6011-6260	260	Ø 6mm

Kirschner Wire Threaded Point

REF. NO (SS)	LENGTH (mm)	DIAMETER
6091-0830	300	Ø 0.8 mm
6091-1030	300	Ø 1.0 mm
6091-1230	300	Ø 1.2 mm
6091-1530	300	Ø 1.5 mm
6091-1830	300	Ø 1.8 mm
6091-2030	300	Ø 2.0 mm
6091-2530	300	Ø 2.5 mm
6091-3030	300	Ø 3.0 mm
6091-3530	300	Ø 3.5 mm
6091-4030	300	Ø 4.0 mm

Kirschner Wire Trocar Point

REF. NO (SS)	LENGTH (mm)	DIAMETER
6041-0830	300	Ø 0.8 mm
6041-1030	300	Ø 1.0 mm
6041-1230	300	Ø 1.2 mm
6041-1530	300	Ø 1.5 mm
6041-1830	300	Ø 1.8 mm
6041-2030	300	Ø 2.0 mm
6041-2530	300	Ø 2.5 mm
6041-3030	300	Ø 3.0 mm
6041-3530	300	Ø 3.5 mm

Steinmann Pin

REF. NO (SS)	LENGTH (mm)	DIAMETER
6031-4030	300	Ø 4.0 mm
6031-4530	300	Ø 4.5 mm
6031-5030	300	Ø 5.0 mm
6031-6030	300	Ø 6.0 mm

Plate Systems & Screws

- Large Fragment Locking Plate System
- Large Fragment Screws
- Small Fragment Locking Plate System
- Pelvic & Acetabulum Plate System
- Small Fragment Screw
- Cannulated Screws
- Headless Cannulated Screws
- Locking Mini Plate System
- Locking DHS-DCS Plate System

Polyaxial Screws

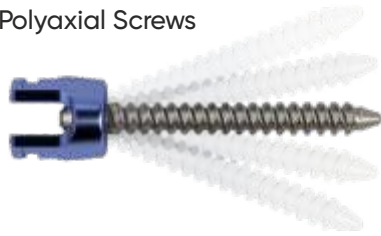

REF. NO (TI) Ø 4.5 mm	REF. NO (TI) Ø 5.5 mm	REF. NO (TI) Ø 6.5 mm	REF. NO (TI) Ø 7.5 mm	SIZE (mm)
3012-4525	-	-	-	25
3012-4530	3012-5530	3012-6530	3012-7530	30
3012-4535	3012-5535	3012-6535	3012-7535	35
3012-4540	3012-5540	3012-6540	3012-7540	40
3012-4545	3012-5545	3012-6545	3012-7545	45
-	3012-5550	3012-6550	3012-7550	50
-	3012-5555	3012-6555	3012-7555	55
-	3012-5560	3012-6560	3012-7560	60

Monoaxial Screws



REF. NO (TI) Ø 4.5 mm	REF. NO (TI) Ø 5.5 mm	REF. NO (TI) Ø 6.5 mm	REF. NO (TI) Ø 7.5 mm	SIZE (mm)
3022-4525	-	-	-	25
3022-4530	3022-5530	-	-	30
3022-4535	3022-5535	3022-6535	-	35
3022-4540	3022-5540	3022-6540	-	40
-	3022-5545	3022-6545	-	45
-	3022-5550	3022-6550	-	50
-	3022-5555	3022-6555	-	55

Spondylolisthesis Polyaxial Screws

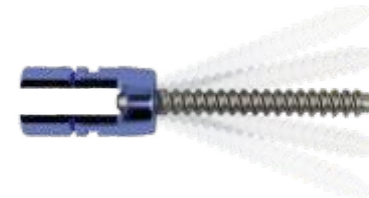

REF. NO (TI) Ø 4.5 mm	REF. NO (TI) Ø 5.5 mm	REF. NO (TI) Ø 6.5 mm	REF. NO (TI) Ø 7.5 mm	SIZE (mm)
3032-4525	-	-	-	25
3032-4530	3032-5530	3032-6530	3032-7530	30
3032-4535	3032-5535	3032-6535	3032-7535	35
3032-4540	3032-5540	3032-6540	3032-7540	40
3032-4545	3032-5545	3032-6545	3032-7545	45
-	3032-5550	3032-6550	3032-7550	50
-	3032-5555	3032-6555	3032-7555	55
-	3032-5560	3032-6560	3032-7560	60

Angled Transvers Connector



REF. NO (TI)	SIZE (mm)
3082-0060	60
3082-0065	65
3082-0070	70
3082-0075	75
3082-0080	80

Transvers Connector Hook



REF. NO (TI)
3072-0001

Arthroplasty Systems

- Hip Joint Prosthesis
- Revision Hip Joint Prosthesis
- Total Knee Joint Prosthesis
- Vision-R Knee

Spinal Rod Ø 5.5 mm



REF. NO (TI)	SIZE (mm)
3052-5505	50
3052-5507	70
3052-5509	90
3052-5510	100
3052-5511	110
3052-5513	130
3052-5515	150
3052-5517	170
3052-5518	180
3052-5520	200
3052-5522	220
3052-5524	240
3052-5526	260
3052-5540	400

Transvers Connector Crosslink



REF. NO (TI)	SIZE (mm)
3062-0360	60
3062-0365	65
3062-0370	70
3062-0375	75
3062-0380	80

Nail System

- PFNA Nail System
- ZFN Multi-Purpose Femoral Nail Systems
- Femur-Tibia Arthrodesis Nail Systems
- Retrograde Femoral Nail
- ZTN Tibial Nail Systems
- Cannulated Intramedullary Humeral Nail
- Titanium Elastic Nail

External Fixation System

- External Fixator
- External Hybrid Fixator
- Small External Tubular Fixator
- Large External Tubular Fixator

Skeletal Pin and Wires

Spinal System

Arthroscopy



Plate Systems & Screws

- Large Fragment Locking Plate System
- Large Fragment Screws
- Small Fragment Locking Plate System
- Pelvic & Acetabulum Plate System
- Small Fragment Screw
- Cannulated Screws
- Headless Cannulated Screws
- Locking Mini Plate System
- Locking DHS-DCS Plate System



Arthroplasty Systems

- Hip Joint Prosthesis
- Revision Hip Joint Prosthesis
- Total Knee Joint Prosthesis
- Vision-R Knee



Nail System

- PFNA Nail System
- ZFN Multi-Purpose Femoral Nail Systems
- Femur-Tibia Arthrodesis Nail Systems
- Retrograde Femoral Nail
- ZTN Tibial Nail Systems
- Cannulated Intramedullary Humeral Nail
- Titanium Elastic Nail



External Fixation System

- External Fixator
- External Hybrid Fixator
- Small External Tubular Fixator
- Large External Tubular Fixator

- Skeletal Pin and Wires
- Spinal System

Arthroscopy



U Staple (TI)

REF. NO	LENGTH (mm)
6062-0006	6
6062-0008	8
6062-0010	10
6062-0012	12

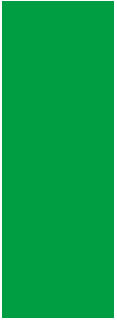

zimed[®]

ISO 9001:2015
ISO 13485:2016



ZC.00.01/02 Yayın Tarihi:29.11.2023